

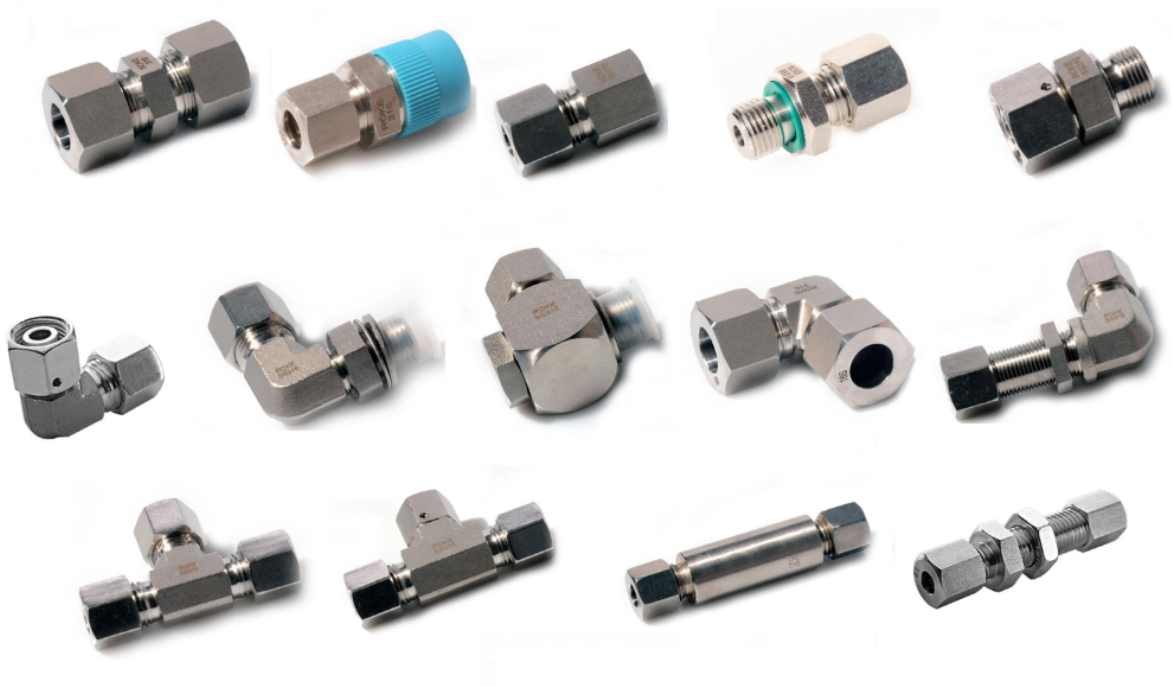

Hydraulic Fittings







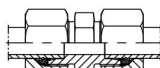
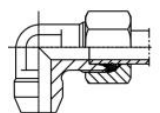
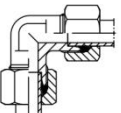
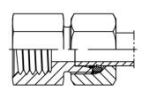
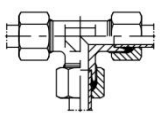

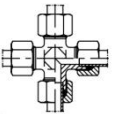
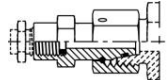
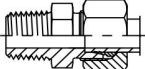
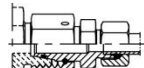
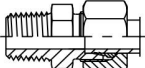
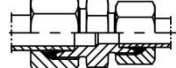
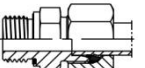
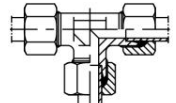
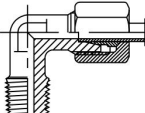
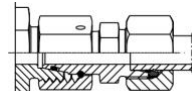
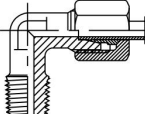
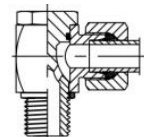
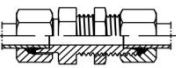
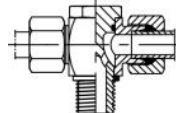
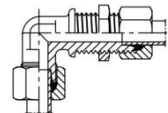
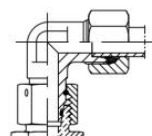
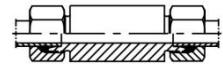
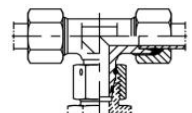
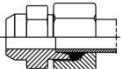

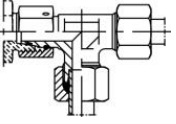
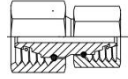
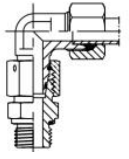
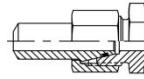
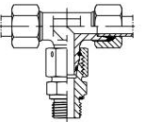
ROKE
Valves and Fittings

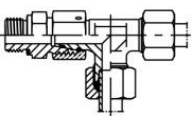
www.chinaroke.com

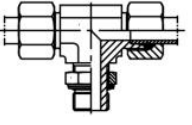
Contents

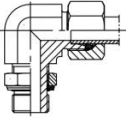
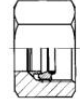
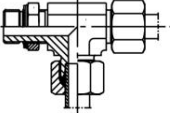
Union -G 	01	Weld Elbow -WAS 	10
Union Elbow -W 	01	Female Connector -GAI-R/M 	11
Union Tee -T 	02	Gauge Connector -MAV 	12
Union Cross -K 	02	Gauge Swivel Connector -MAVE 	12
Male Connector - GE-R/M 	03	The End Reducer -RED-L/S 	13
Male Connector - GE-NPT 	03	Straight Reducer -GR 	15
Male Connector - GE-ED 	04	Tee Reducer -TR 	16
Male Elbow - WE-R/M 	07	Distance Piece Reducer -DA 	17
Male Elbow - WE-NPT 	08	High Pressure Banjo Elbow -WH 	17
Bulkhead Union -SV 	08	High Pressure Banjo Tee -TH 	18
Bulkhead Union Elbow -WSV 	09	Swivel Nut Elbow -EW 	19
Weld Bulkhead Union -ESV 	09	Swivel Nut Branch Tee -ET 	20
Weld Connector -AS 	10		

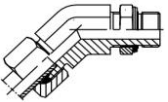
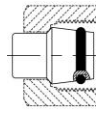
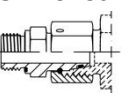
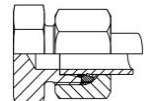
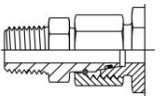
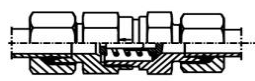
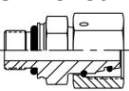
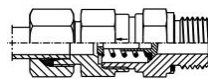
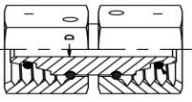
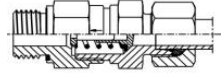
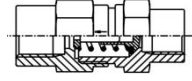
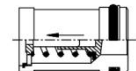
Swivel Nut Run Tee -EL	20	Swivel Nut Union Reducer -GZR	32
			
Swivel Elbow -EW-R/M-ED	21	Weld Nipple -SKA	33
			
Swivel Branch Tee -ET-R/M-ED	22	Nut -M	33
			
Swivel Run Tee -EL-R/M-ED	23	Progressive Ring -DPR	33
			
Adjustable Lock Nut Branch Tee -TEE	24	Cutting Lock Ring -D	33
			
Adjustable Lock Nut Branch Elbow -WEE	25	Dual Function Nut -FM	34
			
Adjustable Lock Nut Run Tee -LEE	27	Soft Sealing Ring -DOZ	34
			
Adjustable Lock Nut Branch 45° Elbow -VEE	28	Fitting Cap -VKA	34
			
Swivel Connector -EGE-R/M-ED	30	Tube End Plug -ROV	35
			
Swivel Connector -EGE-NPT	31	No-return Valve Union -RHD	35
			
Swivel Connector -EGEO	32	No-return Valve Male Connector -RHV	36
			
Swivel Nut Union -GZ	31	No-return Valve Male Connector -RHZ	37
			
		No-return Valve Female Union -RHD1	38
			
		Cartridge Valve -RVP	38
			

Installation Instructions

Tube Fittings

These instructions apply both to traditional fittings and to fittings with the advanced back-ferrule geometry.

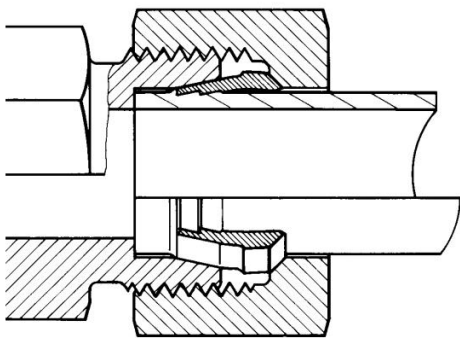
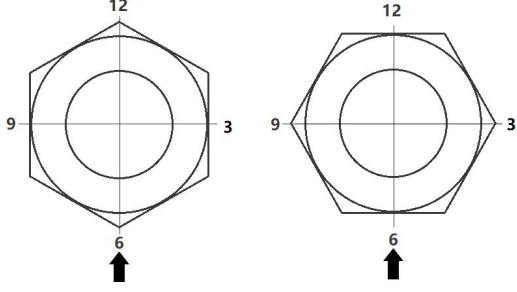
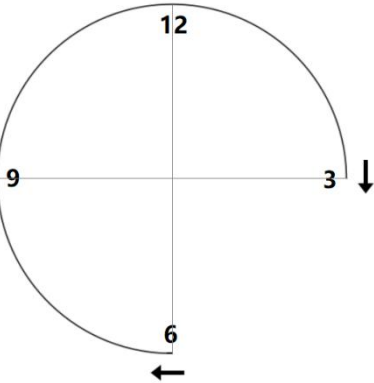
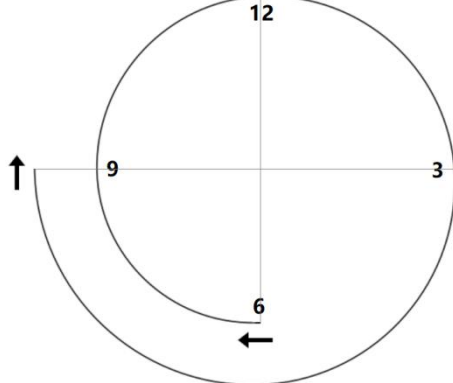
 <p>Fully insert the tube into the fitting and against the shoulder; rotate the nut finger-tight.</p>	 <p>Mark the nut at the 6 o'clock position.</p>
 <p>1/16, 1/8, and 3/16 in.; 2, 3, and 4 mm tube fittings, tighten the nut only three-quarters turn to the 3 o'clock position.</p>	 <p>1/4 to 1 inch., and 6mm to 25 mm tube fittings, tighten the nut one and one-quarters turn to the 9 o'clock position.</p>

Materials

Designator	Material	Bar Stock	Forged
SS	Stainless Steel 316	ASTM A276	ASTM A182
S4	Stainless Steel 304	ASTM A276	ASTM A182
CS	Carbon Steel	ASTM A108	ASTM A105
B	Brass	ASTM B16/B453	ASTM B283
AL	Aluminum	ASTM B211	ASTM B247

Part NO. Discription

For Example: **SS-JMC-AN 8-MN 8**

Material	Series	AN: Male Flared AS: Female Flared	Flared Size	Thread Type :	Thread Size
SS: SS 316			2: 1/8"	FN: Female Npt	2: 1/8"
S9: SS 904L			4: 1/4"	MN: Male Npt	4: 1/4"
S4: SS 304			6: 3/8"	FR: Female BSPT	6: 3/8"
M4: Monle 400			8: 1/2"	MR: Male BSPT	8: 1/2"
B: Brass			12: 3/4"	SAE: UNF	12: 3/4"
CS: Carbon Steel			16: 1"		16: 1"

Union - G

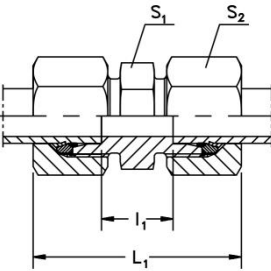

G Part NO.	Series Working Pressure (bar/psi)	Tube O.d.	L1	L1	S1	S2
-G04LL	LL very light 100 bar 1450psi	4	12	31	9	10
-G06LL		6	9	32	11	12
-G08LL		8	12	35	12	14
-G10LL		10	12	35	14	17
-G12LL		12	11	35	17	19
-G06L	L light 315 bar 4560psi	6	10	39	12	14
-G08L		8	11	40	14	17
-G10L		10	13	42	17	19
-G12L		12	14	43	19	22
-G15L		15	16	46	24	27
-G18L	18	16	48	27	32	
-G22L	160 bar 2320psi	22	20	52	32	36
-G28L		28	21	54	41	41
-G35L		35	20	63	46	50
-G42L		42	21	66	55	60
-G06S	S heavy 630 bar 9130psi	6	16	45	14	17
-G08S		8	18	47	17	19
-G10S		10	17	49	19	22
-G12S		12	19	51	22	24
-G14S		14	22	57	24	27
-G16S	400 bar 5800psi	16	21	57	27	30
-G20S		20	23	66	32	36
-G25S		25	26	74	41	46
-G30S		30	27	80	46	50
-G38S	315 bar 4560psi	38	29	90	55	60

Elbow Union - W

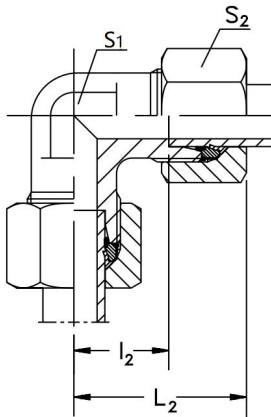

W Part NO.	Series Working Pressure (bar/psi)	Tube O.d.	L2	L2	S1	S2
-W04LL	LL very light 100 bar 1450psi	4	11	21	9	10
-W06LL		6	9.5	21	11	12
-W08LL		8	11.5	23	12	14
-W10LL		10	12.5	24	14	17
-W12LL		12	13	25	17	19
-W06L	L light 315 bar 4560psi	6	12	27	12	14
-W08L		8	14	29	14	17
-W10L		10	15	30	17	19
-W12L		12	17	32	19	22
-W15L		15	21	36	19	27
-W18L	18	23.5	40	24	32	
-W22L	160 bar 2320psi	22	27.5	44	27	36
-W28L		28	30.5	47	36	41
-W35L		35	34.5	56	41	50
-W42L		42	40	63	50	60
-W06S	S heavy 630 bar 9130psi	6	16	31	14	17
-W08S		8	17	32	17	19
-W10S		10	17.5	34	19	22
-W12S		12	21.5	38	22	24
-W14S		14	22	40	19	27
-W16S	400 bar 5800psi	16	24.5	43	24	30
-W20S		20	26.5	48	27	36
-W25S		25	30	54	36	46
-W30S		30	35.5	62	41	50
-W38S	315 bar 4560psi	38	41	72	50	60

Union Tee - T

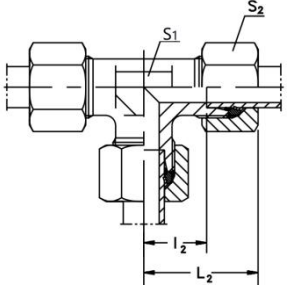

T Part NO.	Series Working Pressure (bar/psi)	Tube O.d.	L2	L2	S1	S2
-T04LL	LL very light 100 bar 1450psi	4	11	21	9	10
-T06LL		6	9.5	21	11	12
-T08LL		8	11.5	23	12	14
-T10LL		10	12.5	24	14	17
-T12LL		12	15	27	14	19
-T06L	L light 315 bar 4560psi	6	12	27	12	14
-T08L		8	14	29	14	17
-T10L		10	15	30	17	19
-T12L		12	17	32	17	22
-T15L		15	21	36	19	27
-T18L	160 bar 2320psi	18	23.5	40	24	32
-T22L		22	27.5	44	27	36
-T28L		28	30.5	47	36	41
-T35L		35	34.5	56	41	50
-T42L		42	40	63	50	60
-T06S	S heavy 630 bar 9130psi	6	16	31	14	17
-T08S		8	17	32	14	19
-T10S		10	17.5	34	17	22
-T12S		12	21.5	38	17	24
-T14S		14	22	40	19	27
-T16S	400 bar 5800psi	16	24.5	43	24	30
-T20S		20	26.5	48	27	36
-T25S		25	30	54	36	46
-T30S		30	35.5	62	41	50
-T38S		38	41	72	50	60
	315 bar 4560psi					

Union Cross - K

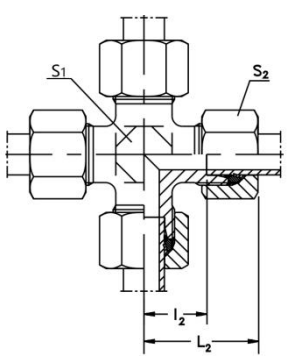

K Part NO.	Series Working Pressure (bar/psi)	Tube O.d.	L2	L2	S1	S2
-K04LL	LL very light 100 bar 1450psi	4	11	21	9	10
-K06LL		6	9.5	21	9	12
-K08LL		8	11.5	23	12	14
-K06L	L light 315 bar 4560psi	6	12	27	12	14
-K08L		8	14	29	12	17
-K10L		10	15	30	14	19
-K12L		12	17	32	17	22
-K15L		15	21	36	19	27
-K18L	160 bar 2320psi	18	23.5	40	24	32
-K22L		22	27.5	44	27	36
-K28L		28	30.5	47	36	41
-K35L		35	34.5	56	41	50
-K42L		42	40	63	50	60
-K06S	S heavy 630 bar 9130psi	6	16	31	12	17
-K08S		8	17	32	14	19
-K10S		10	17.5	34	17	22
-K12S		12	21.5	38	17	24
-K14S		14	22	40	19	27
-K16S	400 bar 5800psi	16	24.5	43	24	30
-K20S		20	26.5	48	27	36
-K25S		25	30	54	36	46
-K30S		30	35.5	62	41	50
-K38S		38	41	72	50	60
	315 bar 4560psi					

Male Connector - GE-R

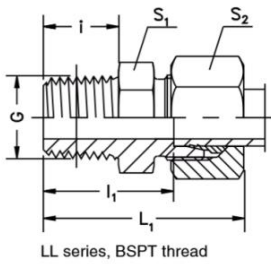

GE-R Part NO.	Series Working Pressure (bar/psi)	Tube O.d.	G Male BSPT	i	I4	L4	S1	S2	
-GE04LLR1/8	LL Very light 100 bar 1450 psi	4	R1/8	10	18.5	28	11	10	
-GE06LLR1/8		6	R 1/8	10	16.5	28	11	12	
-GE08LLR1/8		8	R 1/8	10	18.5	30	12	14	
-GE06LR1/8	L Light 315 bar 4560psi	6	R 1/8	10	17	32	12	14	
-GE06LR1/4		6	R 1/4	15	23	38	17	14	
-GE08LR1/4		8	R 1/4	15	23	38	17	17	
-GE10LR1/4		10	R 1/4	15	24	39	17	19	
-GE10LR3/8		10	R 3/8	15.3	25	40	19	19	
-GE12LR1/4		12	R 1/4	15	25	40	19	22	
-GE12LR3/8		12	R 3/8	15.3	25	40	19	22	
-GE12LR1/2		12	R 1/2	20	30	45	22	22	
-GE15LR1/2		15	R 1/2	20	31	46	24	27	
-GE18LR1/2		18	R 1/2	20	31.5	48	27	32	
-GE22LR3/4		160bar 2320psi	22	R 3/4	20	33.5	50	32	36
-GE28LR1			28	R 1	25	39.5	56	41	41
-GE35LR11/4	35		R 1 1/4	25.5	40.5	62	46	50	
-GE42LR11/2	42		R 1 1/2	26	42	65	55	60	
-GE06SR1/4	S heavy 630bar 9130psi	6	R 1/4	15	28	43	17	17	
-GE08SR1/4		8	R 1/4	15	28	43	17	19	
-GE10SR1/4		10	R 1/4	15	27.5	44	19	22	
-GE10SR3/8		10	R 3/8	15.3	27.5	44	19	22	
-GE12SR1/4		12	R 1/4	15	29.5	46	22	24	
-GE12SR3/8		12	R 3/8	15.3	29.5	46	22	24	
-GE12SR1/2		12	R 1/2	20	34.5	51	22	24	
-GE14SR1/2		14	R 1/2	20	36	54	24	27	
-GE16SR1/2	400bar 5800psi	16	R 1/2	20	35.5	54	27	30	
-GE20SR3/4		20	R 3/4	20	37.5	59	32	36	
-GE25SR1		25	R 1	25	45	69	41	46	
-GE30SR11/4		30	R 1 1/4	25.5	46.5	73	46	50	
-GE38SR11/2	315bar 4560psi	38	R 1 1/2	26	49	80	55	56	

Male Connector - GE-NPT

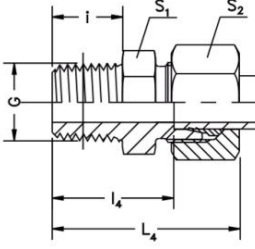

GE-NPT Part NO.	Series Working Pressure (bar/psi)	Tube O.d.	G Male thread NPT	i	I4	L4	S1	S2
-GE04LL1/8NPT	LL Very light 100 bar 1450 psi	4	1/8-27 NPT	10	18.5	28	11	10
-GE06LL1/8NPT		6	1/8-27 NPT	10	16.5	28	11	12
-GE08LL1/8NPT		8	1/8-27 NPT	10	18.5	30	12	14
-GE06L1/8NPT	L Light 315 bar 4560psi	6	1/8-27 NPT	10	17	32	12	14
-GE06L1/4NPT		6	1/4-18 NPT	15	23	38	17	14
-GE08L1/4NPT		8	1/4-18 NPT	15	23	38	17	17
-GE10L1/4NPT		10	1/4-18 NPT	15	24	39	17	19
-GE10L3/8NPT		10	3/8-18 NPT	15.3	25	40	19	19
-GE12L1/4NPT		12	1/4-18 NPT	15	25	40	19	22
-GE12L3/8NPT		12	3/8-18 NPT	15.3	25	40	19	22
-GE12L1/2NPT		12	1/2-14 NPT	20	30	45	22	22
-GE15L1/2NPT		15	1/2-14 NPT	20	31	46	24	27
-GE18L1/2NPT		18	1/2-14 NPT	20	31.5	48	27	32
-GE22L3/4NPT	160bar 2320psi	22	3/4-14 NPT	20	33.5	50	32	36
-GE28L1NPT		28	1-11.5 NPT	25	39.5	56	41	41
-GE35L11/4NPT		35	1 1/4-11.5 NPT	25.5	40.5	62	46	50
-GE42L11/2NPT		42	1 1/2-11.5 NPT	26	42	65	55	60
-GE06S1/4NPT	S heavy 630bar 9130psi	6	1/4-18 NPT	15	28	43	17	17
-GE08S1/4NPT		8	1/4-18 NPT	15	28	43	17	19
-GE10S1/4NPT		10	1/4-18 NPT	15	27.5	44	19	22
-GE10S3/8NPT		10	3/8-18 NPT	15.3	27.5	44	19	22
-GE12S1/4NPT		12	1/4-18 NPT	15	29.5	46	22	24
-GE12S3/8NPT		12	3/8-18 NPT	15.3	29.5	46	22	24
-GE12S1/2NPT		12	1/2-14 NPT	20	34.5	51	22	24
-GE14S1/2NPT	14	1/2-14 NPT	20	36	54	24	27	
-GE16S1/2NPT	400bar 5800psi	16	1/2-14 NPT	20	35.5	54	27	30
-GE20S3/4NPT		20	3/4-14 NPT	20	37.5	59	32	36
-GE25S1NPT		25	1-11.5 NPT	25	45	69	41	46
-GE30S11/4NPT		30	1 1/4-11.5 NPT	25.5	46.5	73	46	50
-GE38S11/2NPT	315bar 4560psi	38	1 1/2-11.5 NPT	26	49	80	55	56

Male Connector - GE-R-ED

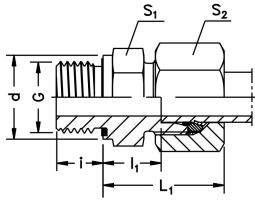

GE-R-ED Part NO.	Series Working Pressure (bar/psi)	Tube O.d.	G Male thread BSPP	d	i	I1	L1	S1	S2
-GE04LLRED	LL very light 100 bar 1450psi	4	G 1/8A	14	8	9.5	19	14	10
-GE06LLRED		6	G 1/8A	14	8	8	20	14	12
-GE06LRED	L light 315 bar 4560psi	6	G1/8A	14	8	8.5	23	14	14
-GE06LR1/4ED		6	G1/4A	19	12	10	25	19	14
-GE08LR1/8ED		8	G1/8A	14	8	9.5	24	14	17
-GE08LRED		8	G1/4A	19	12	10	25	19	17
-GE08LR3/8ED		8	G3/8A	22	12	11.5	26	22	17
-GE10LRED		10	G1/4A	19	12	11	26	19	19
-GE10LRED3/8ED		10	G3/8A	22	12	12.5	27	22	19
-GE10LRED1/2ED		10	G1/2A	27	14	13	28	27	19
-GE12LRED1/4ED		12	G1/4A	19	12	12	27	19	22
-GE12LRED		12	G3/8A	22	12	12.5	27	22	22
-GE12LR1/2ED		12	G1/2A	27	14	13	28	27	22
-GE15LR3/8ED		15	G3/8A	22	12	13.5	29	24	27
-GE15LRED		15	G1/2A	27	14	14	29	27	27
-GE18LRED		18	G1/2A	27	14	14.5	31	27	32
-GE18LR3/4ED		18	G3/4A	32	16	14.5	31	32	32
-GE22LRED	160 bar 2320psi	22	G3/4A	32	16	16.5	33	32	36
-GE28LRED		28	G1A	40	18	17.5	34	41	41
-GE35LRED		35	G 1 1/4 A	50	20	17.5	39	50	50
-GE42LRED		42	G 1 1/2 A	55	22	19	42	55	60
-GE06SRED	S Heavy 630bar 9130psi	6	G 1/4A	19	12	13	28	19	17
-GE08SRED		8	G 1/4A	19	12	15	30	19	19
-GE08SR3/8ED		8	G 3/8A	22	12	15.5	30	22	19
-GE10SR1/4ED		10	G 1/4A	19	12	14.5	31	19	22
-GE10SRED		10	G 3/8A	22	12	15	31	22	22
-GE10SR1/2ED		10	G 1/2A	27	14	17.5	34	27	22
-GE12SR1/4ED		12	G 1/4A	19	12	16.5	33	22	24
-GE12SRED		12	G 3/8A	22	12	17	33	22	24
-GE12SR1/2ED		12	G 1/2A	27	14	17.5	34	27	24
-GE14SRED		14	G 1/2A	27	14	19	37	27	27
-GE16SR3/8ED	400bar 5800psi	16	G 3/8A	22	12	18	36	27	30
-GE16SRED		16	G 1/2A	27	14	18.5	37	27	30
-GE16SR3/4ED		16	G 3/4A	27	16	20.5	39	32	30
-GE20SRED		20	G 3/4A	32	16	20.5	42	32	36
-GE25SR1/2ED		25	G 1/2A	27	14	23	47	41	46
-GE25SRED		25	G 1 A	40	18	23	47	41	46
-GE30SRED		30	G 1 1/4A	50	20	23.5	50	50	50
-GE38SRED	315bar 4560psi	38	G 1 1/2A	55	22	26	57	55	60

Male Connector - GE-M-ED

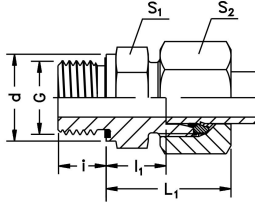

GE-M-ED Part NO.	Series Working Pressure (bar/psi)	Tube O.d.	G Male Metric thread	d7	i	I1	L1	S1	S2
-GE06LMED	L light 315 bar 4560psi	6	M10*1	14	8	8.5	23	14	14
-GE08LMED		8	M12*1.5	17	12	10	25	17	17
-GE10LMED		10	M14*1.5	19	12	11	26	19	19
GE12LMED		12	M16*1.5	22	12	12.5	27	22	22
-GE12LM18*1.5ED		12	M18*1.5	24	12	12.5	27	24	22
-GE12LM22*1.5ED		12	M22*1.5	27	14	14	29	27	22
-GE15LMED		15	M18*1.5	24	12	13.5	29	24	27
-GE15LM22*1.5ED		15	M22*1.5	27	14	15	30	27	27
-GE18LMED		18	M22*1.5	27	14	14.5	31	27	32
-GE22LMED	160 bar 2320psi	22	M26*1.5	32	16	16.5	33	32	36
-GE28LMED		28	M33*2	40	18	17.5	34	41	41
-GE35LMED		35	M42*2	50	20	17.5	39	50	50
-GE42LMED		42	M48*2	55	22	19	42	55	60
-GE06SMED	S Heavy 630bar 9130psi	6	M12*1.5	17	12	13	28	17	17
-GE08SMED		8	M14*1.5	19	12	15	30	19	19
-GE10SMED		10	M16*1.5	22	12	15	31	22	22
-GE12SMED		12	M18*1.5	24	12	17	33	22	24
-GE14SMED	400bar 5800psi	14	M20*1.5	26	14	19	37	27	27
-GE16SMED		16	M22*1.5	27	14	18.5	37	27	30
-GE20SMED		20	M27*2	32	16	20.5	42	32	36
-GE25SMED		25	M33*2	40	18	23	47	41	46
-GE30SMED		30	M42*2	50	20	23.5	50	50	50
-GE38SMED		38	M48*2	55	22	26	57	55	60

Male Connector - GEO

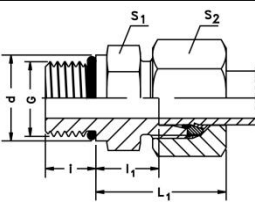

GEO Part NO.	Series Working Pressure (bar/psi)	Tube O.d.	G Male Metric thread	D3	i	I1	L1	S1	S2	O-ring ID&Cross Section
-GEO04LLM	LL Very light 100bar 1450psi	4	M8*1	11	6.5	9.5	19	11	10	6.1*1.6
-GEO04LLM10*1		4	M10*1	13	6.5	9.5	19	13	10	8.1*1.6
-GEO06LLM		6	M10*1	13	6.5	8	19.5	13	12	8.1*1.6
-GEO06LM	L light 315 bar 4560psi	6	M10*1	14	8.5	8.5	23	14	14	8.1*1.6
-GEO08LM		8	M12*1.5	17	11	10	25	17	17	9.3*2.2
-GEO10LM		10	M14*1.5	19	11	11	26	19	19	11.3*2.2
-GEO12LM		12	M16*1.5	22	11.5	12.5	27	22	22	13.3*2.2
-GEO15LM		15	M18*1.5	24	12.5	13.5	29	24	27	15.3*2.2
-GEO18LM		18	M22*1.5	27	13	14.5	31	27	32	19.3*2.2
-GEO22LM27*2	160bar 2320psi	22	M27*1.5	32	16	16.5	33	32	36	23.6*2.9
-GEO28LM		28	M33*2	41	16	17.5	34	41	41	29.6*2.9
-GEO35LM		35	M42*2	50	16	17.5	39	50	50	38.6*2.9
-GEO42LM		42	M48*2	55	17.5	19	42	55	60	44.6*2.9
-GEO06SM	S Heavy 630bar 9130psi	6	M12*1.5	17	11	13	28	17	17	9.3*2.2
-GEO08SM		8	M14*1.5	19	11	15	30	19	19	11.3*2.2
-GEO10SM		10	M16*1.5	22	12.5	15	31	22	22	13.3*2.2
-GEO12SM		12	M18*1.5	24	14	17	33	22	24	15.3*2.2
-GEO16SM	400bar 5800psi	16	M22*1.5	27	15	18.5	37	27	30	19.3*2.2
-GEO20SM		20	M27*2	32	18.5	20.5	42	32	36	23.6*2.9
-GEO25SM		25	M33*2	41	18.5	23	47	41	46	29.6*2.9
-GEO30SM		30	M42*2	50	19	23.5	50	50	50	38.6*2.9
-GEO38SM		38	M48*2	55	21.5	26	57	55	60	44.6*2.9

Male Elbow - WE-R

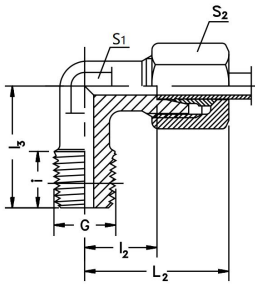

WE-R Part NO.	Series Working Pressure (bar/psi)	Tube O.d.	G Male BSPT thread	i	I2	I3	L2	S1	S2
-WE04LLR	LL very light 100 bar 1450psi	4	R1/8 keg	9.5	11	17	21	11	10
-WE06LLR		6	R1/8 keg	9.5	9.5	17	21	11	12
-WE08LLR		8	R1/8 keg	9.5	12	20	23	12	14
-WE10LLR		10	R1/4keg	14	13	23	24	14	17
-WE12LLR		12	R1/4keg	14	13	23	25	17	19
-WE06LR	L light 315 bar 4560psi	6	R1/8keg	8	12	20	27	12	14
-WE08LR		8	R1/4keg	12	14	26	29	14	17
-WE10LR		10	R1/4keg	12	15	27	30	17	19
-WE12LR		12	R3/8keg	12	17	28	32	19	22
-WE15LR		15	R1/2keg	14	21	34	36	19	27
-WE18LR		18	R1/2keg	17	24	36	40	24	32
-WE06SR	S heavy 400 bar 5800psi	6	R1/4keg	14	16	26	31	14	17
-WE08SR		8	R1/4keg	12	17	27	32	17	19
-WE10S		10	R3/8keg	12	18	28	34	19	22
-WE12S		12	R3/8keg	12	22	28	38	22	24
-WE14S		14	R1/2keg	14	22	32	30	19	27
-WE16S		16	R1/2keg	17	25	32	43	24	30

Male Elbow - WE-M

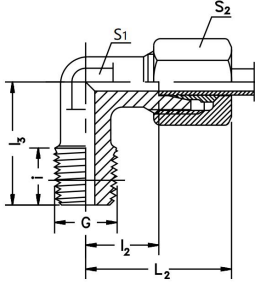

WE-M Part NO.	Series Working Pressure (bar/psi)	Tube O.d.	G Male metric thread	i	I2	I3	L2	S1	S2
-WE04LLM	LL very light 100 bar 1450psi	4	M8*1 keg	9.5	11	17	21	11	10
-WE06LLM		6	M10*1 keg	9.5	9.5	17	21	11	12
-WE08LLM		8	M10*1 keg	9.5	12	20	23	12	14
-WE06LM	L light 315 bar 4560psi	6	M10*1 keg	8	12	20	27	12	14
-WE08LM		8	M12*1 .5keg	12	14	26	29	14	17
-WE10LM		10	M14*1 .5keg	12	15	27	30	17	19
-WE12LM		12	M16*1 .5keg	12	17	28	32	19	22
-WE15LM		15	M18*1 .5keg	12	21	32	36	19	27
-WE18LM		18	M22*1 .5keg	17	24	36	40	24	32
-WE06SM	S heavy 400 bar 5800psi	6	M12*1 .5keg	14	16	26	31	14	17
-WE08SM		8	M14*1 .5keg	12	17	27	32	17	19
-WE10SM		10	M16*1 .5keg	12	18	28	34	19	22
-WE12SM		12	M18*1 .5keg	12	22	28	38	22	24
-WE14SM		14	M20*1 .5keg	14	22	32	40	19	27
-WE16SM		16	M22*1 .5keg	17	25	32	43	24	30

Male Elbow - WE-NPT

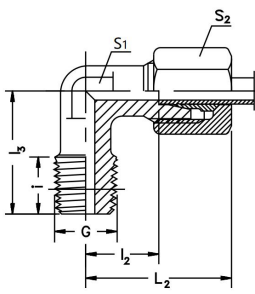

WE-NPT Part no.	Series Working Pressure (bar/psi)	Tube o.d.	G	i	I2	I4	L2	S1	S2
-WE04LL1/8NPT	LL very light 100 bar 1450 psi	4	1/8-27 NPT	10	11	17	21	11	10
-WE06LL1/8NPT		6	1/8-27 NPT	10	9.5	17	21	11	12
-WE08LL1/8NPT		8	1/8-27 NPT	10	11.5	20	23	12	14
-WE06L1/8NPT	L light 315 bar 4560 psi	6	1/8-27 NPT	10	12	20	27	12	14
-WE08L1/4NPT		8	1/4-18 NPT	15	14	26	29	14	17
-WE10L1/4NPT		10	1/4-18 NPT	15	15	27	30	17	19
-WE12L3/8NPT		12	3/8-18 NPT	15.3	17	28	32	19	22
-WE15L1/2NPT		15	1/2-14 NPT	20	21	34	36	19	27
-WE18L1/2NPT		18	1/2-14 NPT	20	23.5	36	40	24	32
-WE22L3/4NPT		22	3/4-14 NPT	20	27.5	42	44	27	36
-WE28L1NPT	160 bar 2320 psi	28	1-11.5 NPT	25	30.5	48	47	36	41
-WE35L11/4NPT		35	1 1/4-11.5 NPT	25.5	34.5	54	56	41	50
-WE42L11/2NPT		42	1 1/2-11.5 NPT	26	40	61	63	50	60
-WE06S1/4NPT	S heavy 630 bar 9130 psi	6	1/4-18 NPT	15	16	26	31	14	17
-WE08S1/4NPT		8	1/4-18 NPT	15	17	27	32	17	19
-WE10S3/8NPT		10	3/8-18 NPT	15.3	17.5	28	34	19	22
-WE12S3/8NPT		12	3/8-18 NPT	15.3	17	28	38	22	24
-WE14S1/2NPT		14	1/2-14 NPT	20	22	34	40	19	27
-WE16S1/2NPT	400 bar 5800 psi	16	1/2-14 NPT	20	24.5	36	43	24	30
-WE20S3/4NPT		20	3/4-14 NPT	20	26.5	42	48	27	36
-WE25S1NPT		25	1-11.5 NPT	25	30	48	54	36	46
-WE30S11/4NPT		30	1 1/4-11.5 NPT	25.5	35.5	54	62	41	50
-WE38S11/2NPT		38	1 1/2-11.5 NPT	26	41	61	72	50	60

Bulkhead Union - SV

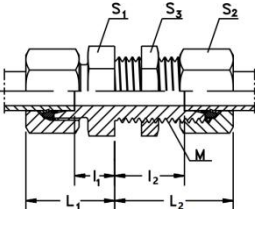

SV Part no.	Series Working Pressure (bar/psi)	Tube o.d.	M	I1	I2	L1	L2	S1	S2	S3
-SV06L	L light 315 bar 4560 psi	6	M12 x 1.5	7	27	22	42	17	14	17
-SV08L		8	M14 x 1.5	8	27	23	42	19	17	19
-SV10L		10	M16 x 1.5	10	28	25	43	22	19	22
-SV12L		12	M18 x 1.5	10	29	25	44	24	22	24
-SV15L		15	M22 x 1.5	12	31	27	46	27	27	30
-SV18L		18	M26 x 1.5	13.5	32.5	30	49	32	32	36
-SV22L	160 bar 2320 psi	22	M30 x 2	16.5	34.5	33	51	36	36	41
-SV28L		28	M36 x 2	18.5	35.5	35	52	41	41	46
-SV35L		35	M45 x 2	18.5	36.5	40	58	50	50	55
-SV42L		42	M52 x 2	19	36	42	59	60	60	65
-SV06S	S heavy 630 bar 9130 psi	6	M14 x 1.5	12	29	27	44	19	17	19
-SV08S		8	M16 x 1.5	13	29	28	44	22	19	22
-SV10S		10	M18 x 1.5	14.5	29.5	31	46	24	22	24
-SV12S		12	M20 x 1.5	14.5	30.5	31	47	27	24	27
-SV14S		14	M22 x 1.5	17	32	35	50	30	27	30
-SV16S	400 bar 5800 psi	16	M24 x 1.5	16.5	31.5	35	50	32	30	32
-SV20S		20	M30 x 2	17.5	33.5	39	55	41	36	41
-SV25S		25	M36 x 2	20	35	44	59	46	46	46
-SV30S		30	M42 x 2	21.5	37.5	48	64	50	50	50
-SV38S	315 bar 4560 psi	38	M52 x 2	22	37	53	68	65	60	65

Bulkhead Union Elbow WSV

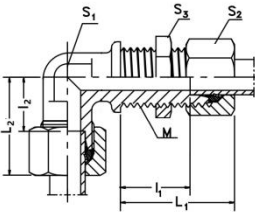

WSV Part no.	Series Working Pressure (bar/psi)	Tube o.d.	M	l1	l2	L1	L2	S1	S2	S3
-WSV06L	L light 315 bar 4560 psi	6	M12 x 1.5	27	12	42	27	14	12	17
-WSV08L		8	M14 x 1.5	27	14	42	29	17	12	19
-WSV10L		10	M16 x 1.5	28	15	43	30	19	14	22
-WSV12L		12	M18 x 1.5	29	17	44	32	22	17	24
-WSV15L		15	M22 x 1.5	31	21	46	36	27	19	30
-WSV18L		18	M26 x 1.5	32.5	23.5	49	40	32	24	36
-WSV22L	160 bar 2320 psi	22	M30 x 2	34.5	27.5	51	44	36	27	41
-WSV28L		28	M36 x 2	35.5	30.5	52	47	41	36	46
-WSV35L		35	M45 x 2	36.5	34.5	58	56	50	41	55
-WSV42L		42	M52 x 2	36	40	59	63	60	50	65
-WSV06S	S heavy 630 bar 9130 psi	6	M14 x 1.5	29	16	44	31	17	12	19
-WSV08S		8	M16 x 1.5	29	17	44	32	19	14	22
-WSV10S		10	M18 x 1.5	29.5	17.5	46	34	22	17	24
-WSV12S		12	M20 x 1.5	30.5	21.5	47	38	24	17	27
-WSV14S		14	M22 x 1.5	32	22	50	40	27	19	30
-WSV16S		16	M24 x 1.5	31.5	24.5	50	43	30	24	32
-WSV20S	400 bar 5800 psi	20	M30 x 2	33.5	26.5	55	48	36	27	41
-WSV25S		25	M36 x 2	35	30	59	54	46	36	46
-WSV30S		30	M42 x 2	37.5	35.5	64	62	50	41	50
-WSV38S		38	M52 x 2	37	41	68	72	60	50	65

Weld Bulkhead Fitting ESV

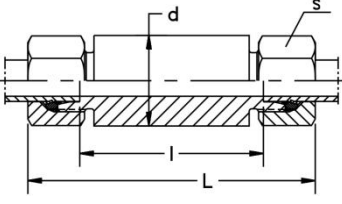

ESV Part no.	Series Working Pressure (bar/psi)	Tube o.d.	d	l	L	S
-ESV06L	L light 315 bar 4560 psi	6	18	56	85	14
-ESV08L		8	20	56	85	17
-ESV10L		10	22	58	87	19
-ESV12L		12	25	58	87	22
-ESV15L		15	28	70	100	27
-ESV18L		18	32	69	101	32
-ESV22L	160 bar 2320 psi	22	36	73	105	36
-ESV28L		28	40	73	106	41
-ESV35L		35	50	71	114	50
-ESV42L		42	60	70	115	60
-ESV06S	S heavy 630 bar 9130 psi	6	20	60	89	17
-ESV08S		8	22	60	89	19
-ESV10S		10	25	59	91	22
-ESV12S		12	28	59	91	24
-ESV14S		14	30	72	107	27
-ESV16S		16	35	71	107	30
-ESV20S	400 bar 5800 psi	20	38	71	114	36
-ESV25S		25	45	72	120	46
-ESV30S		30	50	73	126	50
-ESV38S		38	60	72	133	60

Weld Connector AS

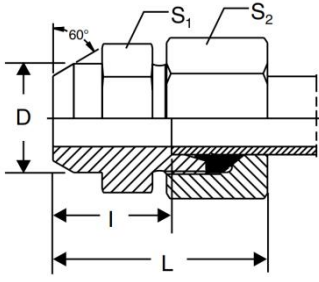
	AS Part no.	Series Working Pressure (bar/psi)	Tube o.d.	D	I	L	S1	S2
	-AS06L	L light 315 bar 4560 psi	6	10	14	29	12	14
	-AS08L		8	12	16	31	14	17
	-AS10L		10	14	18	33	17	19
	-AS12L		12	16	18	33	19	22
	-AS15L		15	19	22	37	22	27
	-AS18L		18	22	23.5	40	27	32
	-AS22L	160 bar 2320 psi	22	27	28.5	45	32	36
	-AS28L		28	32	30.5	47	41	41
	-AS35L		35	40	32.5	54	46	50
	-AS42L		42	46	35	58	55	60
	-AS06S	S heavy 630 bar 9130 psi	6	11	19	34	14	17
	-AS08S		8	13	21	36	17	19
	-AS10S		10	15	22.5	39	19	22
	-AS12S		12	17	24.5	41	22	24
	-AS14S		14	19	27	45	24	27
	-AS16S	400 bar 5800 psi	16	21	26.5	45	27	30
	-AS20S		20	26	29.5	51	32	36
	-AS25S		25	31	32	56	41	46
	-AS30S		30	36	35.5	62	46	50
	-AS38S	315 bar 4560 psi	38	44	38	69	55	60

Weld Elbow WAS

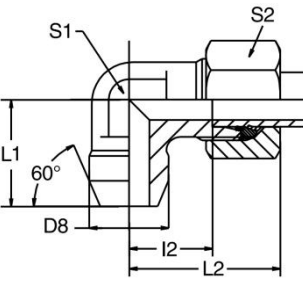
	WAS Part No.	Series Working Pressure (bar/psi)	Tube O.D.	L1	L2	I2	S1	S2	D
	-WAS06L	L light 315 bar 4560 psi	6	19	27	12	14	12	10
	-WAS08L		8	23	29	14	17	12	12
	-WAS10L		10	24	30	15	19	14	14
	-WAS12L		12	25	32	17	22	17	16
	-WAS15L		15	30	36	21	27	19	19
	-WAS18L		18	33	40	23.5	32	24	22
	-WAS22L	160 bar 2320 psi	22	37	44	27.5	36	27	27
	-WAS28L		28	42	47	30.5	41	36	32
	-WAS35L		35	49	56	34.5	50	41	40
	-WAS42L		42	57	63	40	60	50	46
	-WAS06S	S heavy 630 Bar 9130 psi	6	23	31	16	17	12	11
	-WAS08S		8	24	32	17	19	14	13
	-WAS10S		10	25	34	17.5	22	17	15
	-WAS12S		12	29	38	21.5	24	17	17
	-WAS14S		14	30	40	22	27	19	19
	-WAS16S	400 bar 5800 psi	16	33	43	24.5	30	24	21
	-WAS20S		20	37	48	26.5	36	27	26
	-WAS25S		25	42	54	30	46	36	31
	-WAS30S		30	49	62	35.5	50	41	36
	-WAS38S	315bar 4560psi	38	57	72	41	60	50	44

Female Connector GAI-R

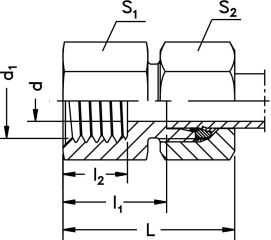

GAI-R Part no.	Series Working Pressure (bar/psi)	Tube o.d.	d1 BSPP thread	d	l1	l2	L	S1	S2
-GAI06LR	L light 315 bar 4560 psi	6	G 1/8	4	19	12	34	14	14
-GAI08LR		8	G 1/4	6	24	17	39	19	17
-GAI08LR3/8		8	G 3/8	6	25	17	40	24	17
-GAI08LR1/2		8	G 1/2	6	29	20	44	27	17
-GAI10LR		10	G 1/4	8	25	17	40	19	19
-GAI10LR3/8		10	G 3/8	8	26	17	41	24	19
-GAI10LR1/2		10	G 1/2	8	30	20	45	27	19
-GAI12LR		12	G 3/8	10	26	17	41	24	22
-GAI12LR1/2		12	G 1/2	10	30	20	45	27	22
-GAI15LR		15	G 1/2	12	31	20	46	27	27
-GAI18LR	18	G 1/2	15	30.5	20	47	27	32	
-GAI22LR	160 bar 2320 psi	22	G 3/4	19	35.5	22	52	36	36
-GAI28LR		28	G 1	24	38	24.5	55	41	41
-GAI35LR		35	G 1 1/4	30	41	26.5	63	55	50
-GAI42LR		42	G 1 1/2	36	42.5	28.5	65	60	60
-GAI06SR	S heavy 400 bar 5800 psi	6	G 1/4	4	26	17	41	19	17
-GAI08SR		8	G 1/4	5	26	17	41	19	19
-GAI10SR		10	G 3/8	7	26.5	17	43	24	22
-GAI12SR		12	G 3/8	8	26.5	17	43	24	24
-GAI14SR		14	G 1/2	10	32	20	50	30	27
-GAI16SR		16	G 1/2	12	31.5	20	50	30	30
-GAI20SR	315 bar	20	G 3/4	16	34.5	22	56	36	36
-GAI25SR	4560 psi	25	G 1	20	37.5	24.5	62	41	46
-GAI30SR		30	G 1 1/4	25	42	26.5	69	55	50
-GAI38SR	250 bar 3625 psi	38	G 1 1/2	32	43.5	28.5	74	60	60

Female Connector GAI-M

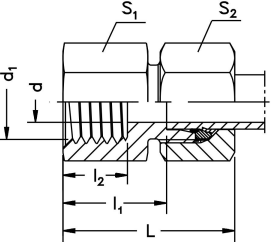

GAI-M Part no.	Series Working Pressure (bar/psi)	Tube o.d.	d1 BSPP thread	d	l1	l2	L	S1	S2
-GAI06LM	L light 315 bar 4560 psi	6	M10x1	4	19.5	12.5	34	14	14
-GAI08LM		8	M12x1.5	6	24	17	39	17	17
-GAI10LM		10	M14x1.5	8	25	17	40	19	19
-GAI12LM		12	M16x1.5	10	26	17	41	22	22
-GAI15LM		15	M18x1.5	12	28	17	43	24	27
-GAI18LM		18	M22x1.5	15	29.5	19	46	30	32
-GAI22LM	160 bar 2320 psi	22	M26x1.5	19	34.5	21	51	32	36
-GAI28LM		28	M33x2	24	37.5	24	54	41	41
-GAI35LM		35	M42x2	30	40.5	26	62	55	50
-GAI42LM		42	M48x2	36	42	28	65	60	60
-GAI06SM	S heavy 400 bar 5800 psi	6	M12x1.5	4	26	17	41	17	17
-GAI08SM		8	M14x1.5	5	26	17	41	17	19
-GAI10SM		10	M16x1.5	7	26.5	17	43	22	22
-GAI12SM		12	M18x1.5	8	27.5	17	44	24	24
-GAI14SM		14	M20x1.5	10	31	19	49	27	27
-GAI16SM		16	M22x1.5	12	30.5	19	49	30	30
-GAI20SM	315 bar 4560 psi	20	M27x2	16	34.5	22	56	36	36
-GAI25SM		25	M33x2	20	37	24	61	41	46
-GAI30SM		30	M42x2	25	41.5	26	68	55	50
-GAI38SM	250 bar	38	M48x2	32	43	28	74	60	60
-GAI16SR	3625 psi	16	G 1/2	12	31.5	20	50	30	30
-GAI20SR	315 bar 4560 psi	20	G 3/4	16	34.5	22	56	36	36
-GAI25SR		25	G 1	20	37.5	24.5	62	41	46
-GAI30SR		30	G 1 1/4	25	42	26.5	69	55	50
-GAI38SR	250 bar 3625 psi	38	G 1 1/2	32	43.5	28.5	74	60	60

BSPP Pressure Gauge Connector MAV

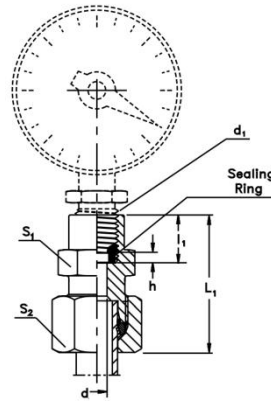

MAV Part no.	Series Working Pressure (bar/psi)	Tube o.d.	d1 BSPP thread	d	h	l1	L1	S1	S2
-MAV04LLR	LL very light 100 bar 1450 psi	4	G 1/4	2.5	4.5	14.5	33	19	10
-MAV06LR	L light 315 bar 4560 psi	6	G 1/4	2.5	4.5	14.5	37	19	14
-MAV08LR		8	G 1/4	5.5	4.5	14.5	37	19	17
-MAV10LR		10	G 1/4	5.5	4.5	14.5	38	19	19
-MAV12LR		12	G 1/4	5.5	4.5	14.5	38	19	22
-MAV06SR	S heavy 630 bar 9130 psi	6	G 1/2	3.5	5	20	46	27	17
-MAV08SR		8	G 1/2	3.5	5	20	46	27	19
-MAV10SR		10	G 1/2	7.5	5	20	47	27	22
-MAV12SR		12	G 1/2	7.5	5	20	47	27	24

BSPP Pressure Gauge Connector MAVE

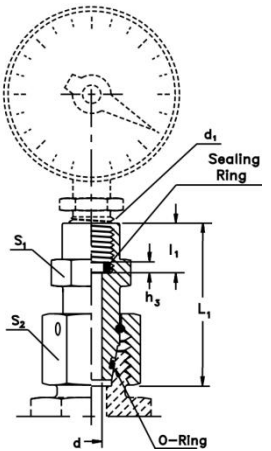

MAVE Part no.	Series Working Pressure (bar/psi)	Tube o.d.	d1 BSPP thread	d	h	l1	L1	S1	S2	O-ring
-MAVE06LR	L light 315 bar 4560 psi	6	G 1/4	2.5	4.5	14.5	35.5	19	14	4.5 x 1.5
-MAVE08LR		8		4					17	6.5 x 1.5
-MAVE10LR		10		5.5					19	8 x 1.5
-MAVE12LR		12		5.5					22	10 x 1.5
-MAVE06SR	S heavy 630 bar 9130 psi	6	G 1/2	2.5	5	20	42.5	27	17	4 x 1.5
-MAVE08SR		8		4					19	6 x 1.5
-MAVE10SR		10		6					22	7.5 x 1.5
-MAVE12SR		12		7					24	9 x 1.5
-MAVE06SR1/4	630 bar 9130 psi	6	G 1/4	2.5	4.5	14.5	35.5	19	17	4 x 1.5
-MAVE08SR1/4		8		4					19	6 x 1.5
-MAVE10SR1/4		10		7					22	7.5 x 1.5
-MAVE12SR1/4		12		7					24	9 x 1.5

Tube End Reducer RED

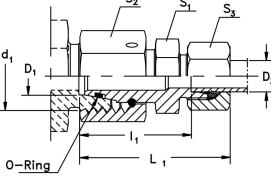

RED Part no.	Series L Working Pressure (bar/psi)	D1	D2	d1	l1	L1	S1	S2	S3	O-ring
-RED06L/04LL	315	6	4	M12 x 1.5	24.5	34	9	14	10	4.5 x 1.5
-RED08/06L		8	6	M14 x 1.5	23.5	38	12	17	14	6.5 x 1.5
-RED10/06L	4560	10	6	M16 x 1.5	25	40	14	19	14	8 x 1.5
-RED10/08L			8		25	40			17	
-RED12/06L	315	12	6	M18 x 1.5	25	40	17	22	14	10 x 1.5
-RED12/08L			8		25	40			17	
-RED12/10L	4560		10		26	41			19	
-RED15/06L	315	15	6	M22 x 1.5	28.5	43	19	27	14	12 x 2
-RED15/08L			8		28.5	43			17	
-RED15/10L	4560		10		29.5	44			19	
-RED15/12L			12	29.5	44	22				
-RED18/06L	315	18	6	M26 x 1.5	28	43	24	32	14	15 x 2
-RED18/08L			8		28	43			17	
-RED18/10L	4560		10		29	44			19	
-RED18/12L			12	29	44	22				
-RED18/15L			15	30	45	27				
-RED22/06L	160	22	6	M30 x 2	32	47	27	36	14	20 x 2
-RED22/08L			8		32	47			17	
-RED22/10L	2320		10		33	48			19	
-RED22/12L			12	33	48	22				
-RED22/15L			15	34	49	27				
-RED22/18L			18		33.5	50			32	
-RED28/06L	160	28	6	M36 x 2	34	49	32	41	14	26 x 2
-RED28/08L			8		34	49			17	
-RED28/10L	2320		10		35	50			19	
-RED28/12L			12	35	50	22				
-RED28/15L			15	36	51	27				
-RED28/18L			18		35.5	52			32	
-RED28/22L			22		37.5	54			36	
-RED35/12L	160	35	12	M45 x 2	38	53	41	50	22	32 x 2.5
-RED35/15L			15		39	54			27	
-RED35/18L	2320		18		38.5	55			32	
-RED35/22L			22	40.5	57	36				
-RED35/28L			28	40.5	57	41				
-RED42/18L	160	42	18	M52 x 2	42	58	50	60	32	38 x 2.5
-RED42/22L			22		44	60			36	
-RED42/28L	2320		28		44	61			41	
-RED42/35L			35	43	65	50				

Tube End Reducer RED

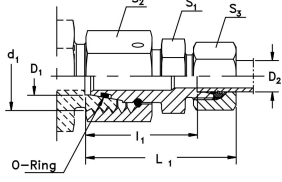

RED Part no.	Series S Working Pressure (bar/psi)	D1	D2	d1	l1	l2	S1	S2	S3	O-ring	
-RED08/06S	630	8	6	M16 x 1.5	27	42	14	19	17	6 x 1.5	
-RED10/06S	9130	10	6	M18 x 1.5	27.5	42	17	22	17	8 x 1.5	
-RED10/08S			8		27.5	42			19		
-RED12/06S	630	12	6	M20 x 1.5	29	44	17	24	17	9 x 1.5	
-RED12/08S	9130		8		29	44			17		19
-RED12/10S			10		29.5	46			19		22
-RED14/06S	630 9130	14	6	M22 x 1.5	31.5	46	19	27	17	11 x 2	
-RED14/08S			8		31.5	46			19		19
-RED14/10S			10		31	47			19		22
-RED14/12S			12		31	47			22		24
-RED16/06S	400 5800	16	6	M24 x 1.5	32	47	22	30	17	13 x 2	
-RED16/08S			8		32	47			22		19
-RED16/10S			10		31.5	48			22		22
-RED16/12S			12		31.5	48			22		24
-RED16/14S			14		33	51			24		27
-RED20/06S	400 5800	20	6	M30 x 2	36	51	27	36	17	16 x 2.4	
-RED20/08S			8		36	51			27		19
-RED20/10S			10		35.5	52			22		22
-RED20/12S			12		35.5	52			24		24
-RED20/14S			14		37	55			27		27
-RED20/16S			16		36.5	55			30		30
-RED25/06S	400 5800	25	6	M36 x 2	38.5	53	32	46	17	20 x 2.4	
-RED25/08S			8		38.5	53			32		19
-RED25/10S			10		38	54			22		22
-RED25/12S			12		38	54			24		24
-RED25/14S			14		39.5	57			27		27
-RED25/16S			16		39	57			30		30
-RED25/20S			20		39	61			36		36
-RED30/08S	400 5800	30	8	M42 x 2	44	59	41	50	19	25 x 2.4	
-RED30/10S			10		43.5	60			41		22
-RED30/12S			12		43.5	60			24		24
-RED30/14S			14		45	63			27		27
-RED30/16S			16		44.5	63			30		30
-RED30/20S			20		44.5	66			36		36
-RED30/25S			25		45	69			46		46
-RED38/12S	315 4560	38	12	M52 x 2	47	63	50	60	24	33 x 2.4	
-RED38/16S			16		48	66			30		30
-RED38/20S			20		48	70			36		36
-RED38/25S			25		48.5	73			46		46
-RED38/30S			30		49	76			50		50

Straight Reducer - GR

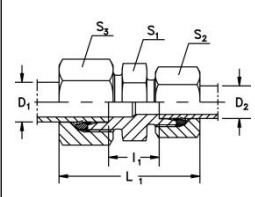

GR Part NO.	Series Working Pressure (bar/psi)	D1 Tube O.d	D2 Tube O.d	I1	L1	S1	S2	S3	
-GR06/04LL	LL	6	4	10.5	32	11	10	12	
-GR08/04LL	very light 100 bar 1450 psi	8	4	12.5	34	12	10	14	
-GR08/06LL		8	6	11	34	12	12	14	
-GR08/06L	L light 315 bar 4560 psi	8	6	11	40	14	14	17	
-GR10/06L		10	6	12	41	17	14	19	
-GR10/08L		10	8	12	41	17	17	19	
-GR12/06L		12	6	13	42	19	14	22	
-GR12/08L		12	8	13	42	19	17	22	
-GR12/10L		12	10	14	43	19	19	22	
-GR15/10L		15	10	15	45	24	19	27	
-GR15/12L		15	12	15	45	24	22	27	
-GR18/10L		18	10	15.5	46	27	19	32	
-GR18/12L		18	12	15.5	46	27	22	32	
-GR18/15L		18	15	16.5	48	27	27	32	
-GR22/12L		160 bar 2320 psi	22	12	17.5	48	32	22	36
-GR22/15L			22	15	18.5	50	32	27	36
-GR22/18L			22	18	18	50	32	32	36
-GR28/18L	28		18	19	52	41	32	41	
-GR28/22L	28		22	21	54	41	36	41	
-GR35/22L	35		22	21	59	46	36	50	
-GR35/28L	35		28	21	59	46	41	50	
-GR08/06S	S heavy 630 bar 9130 psi	8	6	18	47	17	17	19	
-GR10/06S		10	6	17.5	48	19	17	22	
-GR10/08S		10	8	17.5	48	19	19	22	
-GR12/06S		12	6	19.5	50	22	17	24	
-GR12/08S		12	8	19.5	50	22	19	24	
-GR12/10S		12	10	19	51	22	22	24	
-GR14/10S		14	10	20.5	54	24	22	27	
-GR14/12S		14	12	20.5	54	24	24	27	
-GR16/12S		400 bar 5800 psi	16	12	20	54	27	24	30
-GR16/14S			16	14	21.5	57	27	27	30
-GR20/10S	20		10	22	60	32	22	36	
-GR20/12S	20		12	22	60	32	24	36	
-GR20/16S	20		16	23	63	32	30	36	
-GR25/16S	25		16	25.5	68	41	30	46	
-GR25/20S	25		20	25.5	71	41	36	46	
-GR30/20S	30		20	26	74	46	36	50	
-GR30/25S	30		25	26.5	77	46	46	50	
-GR38/30S	315 bar 4560 psi		38	30	29.5	87	55	50	60

Tee Reducer - TR

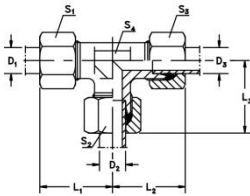

TR Part NO.	Series Working Pressure (bar/psi)	Tube O.d			L1	L2	L3	S1	S2	S3	S4
		D1	D2	D3							
-TR04/08/04LL	LL 100bar 1450psi	4	8	4	23	23	23	10	14	10	12
-TR06/04/06LL		6	4	6	21	21	21	12	10	12	11
-TR06/08/06L		6	8	6	29	29	29	14	17	14	14
-TR08/06/08L		8	6	8	29	29	29	17	14	17	14
-TR06/10/06L		6	10	6	30	30	30	14	19	14	14
-TR08/10/08L		8	10	8	30	30	30	17	19	17	14
-TR10/06/10L		10	6	10	30	30	30	19	14	19	14
-TR10/08/10L		10	8	10	30	30	30	19	17	19	14
-TR10/10/06L		10	10	6	30	30	30	19	19	14	14
-TR08/12/08L		8	12	8	32	32	32	17	22	17	17
-TR12/06/12L	L light 315 bar 4560 psi	12	6	12	32	32	32	22	14	22	17
-TR12/08/08L		12	8	8	32	32	32	22	17	17	17
-TR12/08/12L		12	8	12	32	32	32	22	17	22	17
-TR12/10/10L		12	10	10	32	32	32	22	19	19	17
-TR12/10/12L		12	10	12	32	32	32	22	19	22	17
-TR12/12/10L		12	12	10	32	32	32	22	22	19	17
-TR10/15/10L		10	15	10	36	36	36	19	27	19	19
-TR12/15/12L		12	15	12	36	36	36	22	27	22	19
-TR15/06/15L		15	6	15	36	36	36	27	14	27	19
-TR15/10/15L		15	10	15	36	36	36	27	19	27	19
-TR15/12/12L	15	12	12	36	36	36	27	22	22	19	
-TR15/12/15L	15	12	15	36	36	36	27	22	27	19	
-TR15/15/12L	15	15	12	36	36	36	27	27	22	19	
-TR12/18/12L	12	18	12	39	39	40	22	32	22	24	
-TR18/10/10L	18	10	10	40	39	39	32	19	19	24	
-TR18/10/18L	18	10	18	40	40	39	32	19	32	24	
-TR18/12/18L	18	12	18	40	40	39	32	22	32	24	
-TR18/15/18L	18	15	18	40	40	39	32	27	32	24	
-TR18/18/10L	18	18	10	40	39	40	32	32	19	24	
-TR22/10/22L	L light 160 bar 2320 psi	22	10	22	44	44	43	36	19	36	27
-TR22/12/22L		22	12	22	44	44	43	36	22	36	27
-TR22/15/15L		22	15	15	44	43	43	36	27	27	27
-TR22/15/22L		22	15	22	44	44	43	36	27	36	27
-TR22/18/18L		22	18	18	44	44	44	36	32	32	27
-TR22/18/22L		22	18	22	44	44	44	36	32	36	27
-TR22/22/18L		22	22	18	44	44	44	36	36	32	27
-TR28/10/28L		28	10	28	47	47	46	41	19	41	36
-TR28/12/28L		28	12	28	47	47	46	41	22	41	36
-TR28/15/28L		28	15	28	47	47	46	41	27	41	36
-TR28/18/28L	28	18	28	47	47	47	41	32	41	36	
-TR28/22/22L	28	22	22	47	47	47	41	36	36	36	
-TR28/22/28L	28	22	28	47	47	47	41	36	41	36	
TR10/06/10S	S heavy 630 bar 9130 psii	10	6	10	34	34	33	22	17	22	17
TR12/08/08S		12	8	8	38	37	37	24	19	19	17
TR12/08/12S		12	8	12	38	38	37	24	19	24	17
TR12/10/12S		12	10	12	38	38	38	24	22	24	17
TR12/16/12S	S heavy 400 bar 5800 ps	12	16	12	42	42	43	24	30	24	24
TR16/06/16S		16	6	16	43	43	41	30	17	30	24
TR16/08/16S		16	8	16	43	43	41	30	19	30	24
TR16/10/16S		16	10	16	43	43	42	30	22	30	24
TR16/12/16S		16	12	16	43	43	42	30	24	30	24
TR16/20/16S		16	20	16	47	47	48	30	36	30	27
TR20/10/20S		20	10	20	48	48	46	36	22	36	27
TR20/12/20S		20	12	20	48	48	46	36	24	6	27
TR20/16/20S		20	16	20	48	48	47	36	30	36	27
TR20/25/20S		20	25	20	53	53	54	36	46	36	36
TR25/16/25S	25	16	25	54	54	52	46	30	46	36	
TR25/20/25S	25	20	25	54	54	53	46	36	46	36	
TR25/30/25S	25	30	25	61	61	62	46	50	46	41	

Distance Piece Reducer - DA

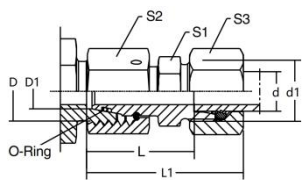

DA Part NO.	Series Working Pressure (bar/psi)	Tube O. d.	D/d	D1/d1	L1	L	S1	S2/S3	O-ring
-DA06L	L light 315 bar 4560 psi	6	9	M 12 X 1.5	51	36	12	14	OR4.5X1.5
-DA08L		8	8	M 14 X 1.5	51	36	14	17	OR6.5X1.5
-DA10L		10	10	M 16 X 1.5	51	36	17	19	OR8X1.5
-DA12L		12	12	M 18 X 1.5	51	36	19	22	OR10X1.5
-DA15L		15	15	M 22 X 1.5	51	36	24	27	OR12X2
-DA18L		18	18	M 26 X 1.5	52	36	27	32	OR15X2
-DA22L	160 bar 2320 psi	22	22	M 30 X 2	56	40	32	36	OR20X2
-DA28L		28	28	M 36 X 2	57	40	41	41	OR26X2
-DA35L		35	35	M 45 X 2	72	50	46	50	OR32X2.5
-DA42L		42	42	M 52 X 2	83	60	55	60	OR38X2.5
-DA06S	S heavy 630 bar 9130 psi 400 bar 5800 psi 315bar 4560psi	6	6	M 14 X 1.5	51	36	12	17	OR4.5X1.5
-DA08S		8	8	M 16 X 1.5	51	36	14	19	OR6.5X1.5
-DA10S		10	10	M 18 X 1.5	52	36	17	22	OR8X1.5
-DA12S		12	12	M 22 X 1.5	52	36	19	24	OR10X1.5
-DA14S		14	14	M 24 X 1.5	58	40	24	27	OR11X2
-DA16S		16	16	M 26 X 1.5	58	40	27	30	OR13X2
-DA20S		20	20	M 30 X 2	68	46	32	36	OR16.3X2.4
-DA25S		25	25	M 36 X 2	74	50	41	46	OR20.3X2.4
-DA30S		30	30	M 45 X 2	83	56	46	50	OR25.3X2.4
-DA38S		38	38	M 52 X 2	91	60	55	60	OR33.3X2.4

High Pressure Banjo Elbow - WH-R

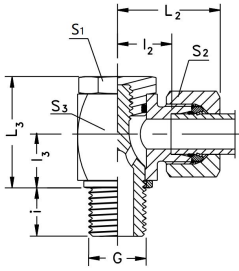

WH-R Part NO.	Series Working Pressure (bar/psi)	Tube O.d	G male thread	i	I2	I3	L2	L3	S1	S2	S3
WH06LR	L light 250 bar 3625 psi	6	G 1/8 A	8	12	10.5	27	24	17	14	17
WH08LR		8	G 1/4 A	12	14.5	14	29	30	19	17	22
WH10LR		10	G 1/4 A	12	15.5	14	30	30	19	19	22
WH12LR		12	G 3/8 A	12	18	16.5	33	36	24	22	27
WH15LR		15	G 1/2 A	14	21.5	21.5	37	45	30	27	32
WH18LR		18	G 1/2 A	14	21	21.5	37	45	30	32	32
WH22LR	160 bar 2320 psi	22	G 3/4 A	16	27.5	24	44	53	36	36	41
WH28LR		28	G 1 A	18	32	30.5	49	66	46	41	50
WH35LR		35	G 1/4 A	20	36	35.5	58	76	55	50	60
WH42LR		42	G 1 1/2 A	22	40.5	40.5	63	87	60	60	70
WH06SR	S heavy 315 bar 4560 psi	6	G 1/4 A	12	16.5	14	31	30	19	17	22
WH08SR		8	G1/4 A	12	16.5	14	31	30	19	19	22
WH10SR		10	G 3/8 A	12	18.5	16.5	35	36	24	22	27
WH12SR		12	G 3/8 A	12	18.5	16.5	35	36	24	24	27
WH14SR		14	G 1/2 A	14	22.5	21.5	40	45	30	27	32
WH16SR		16	G 1/2 A	14	22	21.5	40	45	30	30	32
WH20SR	160 bar 2320psi	20	G 3/4 A	16	26.5	24	48	53	36	36	41
WH25SR		25	G 1 A	18	31.5	30.5	56	66	46	46	50
WH30SR		30	G 1 1/4 A	20	37	34.5	64	76	55	50	60
WH38SR		38	G 1 1/2 A	22	41.5	40.5	72	87	60	60	70

High Pressure Banjo Elbow - WH-M

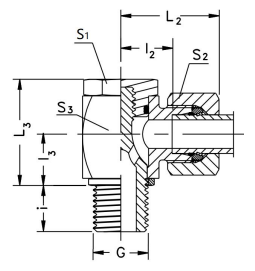

WH-M Part NO.	Series Working Pressure (bar/psi)	Tube O.d	G male thread	i	I2	I3	L2	L3	S1	S2	S3
WH06LM	250 bar 3625 psi	6	M10 x 1	8	12	10.5	27	24	17	14	17
WH08LM		8	M12 x 1.5	12	14.5	14	29	30	19	17	22
WH10LM		10	M14 x 1.5	12	15.5	14	30	30	19	19	22
WH12LM		12	M16 x 1.5	12	18	16.5	33	36	24	22	27
WH15LM		15	M18 x 1.5	12	21.5	18.5	37	39.5	30	27	30
WH18LM		18	M22 x 1.5	14	21	21.5	37	45	30	32	32
WH22LM	160 bar 2320 psi	22	M26 x 1.5	16	27.5	24	44	53	36	36	41
WH28LM		28	M33 x 2	18	32	30.5	49	66	46	41	50
WH35LM		35	M42 x 2	20	36	35.5	58	76	55	50	60
WH42LM		42	M48 x 2	22	40.5	40.5	63	87	60	60	70
WH06SM	315 bar 4560 psi	6	M12 x 1.5	12	16.5	14	31	30	19	17	22
WH08SM		8	M14 x 1.5	12	16.5	14	31	30	19	19	22
WH10SM		10	M16 x 1.5	12	18.5	16.5	35	36	24	22	27
WH12SM		12	M18 x 1.5	12	20	18.5	36	39.5	27	24	27
WH14SM		14	M20 x 1.5	14	22.5	20	40	43.5	30	27	32
WH16SM		16	M22 x 1.5	14	22	21.5	40	45	30	30	32
WH20SM	160 bar 2320 psi	20	M27 x 2	16	26.5	24	48	53	36	36	41
WH25SM		25	M33 x 2	18	31.5	30.5	56	66	46	46	50
WH30SM		30	M42 x 2	20	37	35.5	64	76	55	50	60
WH38SM		38	M48 x 2	22	41.5	40.5	72	87	60	60	70

High Pressure Banjo Tee - TH-R

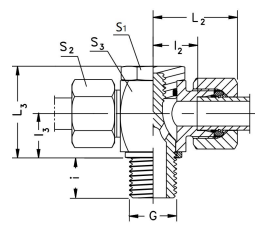

TH-R Part NO.	Series Working Pressure (bar/psi)	Tube O.d	G male thread	i	I2	I3	L2	L3	S1	S2	S3
TH06LR	250 bar 3625 psi	6	G 1/8A	8	12	10.5	27	24	17	14	17
TH08LR		8	G 1/4A	12	14.5	14	29	30	19	17	22
TH10LR		10	G 1/4A	12	15.5	14	30	30	19	19	22
TH12LR		12	G 3/8A	12	18	16.5	33	36	24	22	27
TH15LR		15	G 1/2A	14	21.5	21.5	37	45	30	27	32
TH18LR		18	G 1/2A	14	21	21.5	37	45	30	32	32
TH22LR	160 bar 2320 psi	22	G 3/4A	16	27.5	24	44	53	36	36	41
TH28LR		28	G 1A	18	32	30.5	49	66	46	41	50
TH35LR		35	G 1 1/4A	20	36	35.5	58	76	55	50	60
TH42LR		42	G 1 1/2A	22	40.5	40.5	63	87	60	60	70
TH06SR	315 bar 4560 psi	6	G 1/4A	12	16.5	14	31	30	19	17	22
TH08SR		8	G 1/4A	12	16.5	14	31	30	19	19	22
TH10SR		10	G 3/8A	12	18.5	16.5	35	36	24	22	27
TH12SR		12	G 3/8A	12	18.5	16.5	35	36	24	24	27
TH14SR		14	G 1/2A	14	22.5	21.5	40	45	30	27	32
TH16SR		16	G 1/2A	14	22	21.5	40	45	30	30	32
TH20SR	160 bar 2320 psi	20	G 3/4A	16	26.5	24	48	53	36	36	41
TH25SR		25	G 1A	18	31.5	30.5	56	66	46	46	50
TH30SR		30	G 1 1/4A	20	37	35.5	64	76	55	50	60
TH38SR		38	G 1 1/2A	22	41.5	40.5	72	87	60	60	70

High Pressure Banjo Tee - TH-M

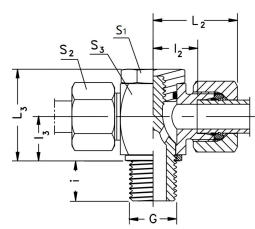

TH-M Part NO.	Series Working Pressure (bar/psi)	Tube O.d	G male thread	i	I2	I3	L2	L3	S1	S2	S3	
TH06LM	L light 250 bar	6	M10 x1	8	12	10.5	27	24	17	14	17	
TH08LM		8	M12 x1.5	12	14.5	14	29	30	19	17	22	
TH10LM		10	M14x1.5	12	15.5	14	30	30	19	19	22	
TH12LM		12	M16x1.5	12	18	16.5	33	36	24	22	27	
TH15LM		15	M18x1.5	12	21.5	18.5	37	39.5	30	27	30	
TH18LM		18	M22x1.5	14	21	21.5	37	45	30	32	32	
TH22LM	160 bar	22	M26x1.5	16	27.5	24	44	53	36	36	41	
TH28LM		28	M33x2	18	32	30.5	49	66	46	41	50	
TH35LM		2320 psi	35	M42x2	20	36	35.5	58	76	55	50	60
TH42LM		42	M48x2	22	40.5	40.5	63	87	60	60	70	
TH06SM	S heavy 315 bar	6	M12 x1.5	12	16.5	14	31	30	19	17	22	
TH08SM		8	M14x1.5	12	16.5	14	31	30	19	19	22	
TH10SM		10	M16x1.5	12	18.5	16.5	35	36	24	22	27	
TH12SM		4560 psi	12	M18x1.5	12	20	18.5	36	39.5	27	24	27
TH14SM		14	M20x1.5	14	22.5	20	40	43.5	30	27	32	
TH16SM		16	M22x1.5	14	22	21.5	40	45	30	30	32	
TH20SM	160 bar	20	M27x2	16	26.5	24	48	53	36	36	41	
TH25SM		25	M33x2	18	31.5	30.5	56	66	46	46	50	
TH30SM		2320 psi	30	M42x2	20	37	35.5	64	76	55	50	60
TH38SM		38	M48x2	22	41.5	40.5	72	87	60	60	70	

Swivel Nut Elbow Fitting - EW

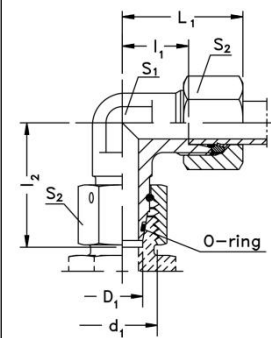

EW Part No.	Series Working Pressure (bar/psi)	Tube o.d.	d1 thread	I1	I2	L1	S1	S2	O-ring	
EW06L	L Light 250 bar	6	M12 x1.5	12	26	27	12	14	OR4.5 x1.5	
EW08L		8	M14x1.5	14	27.5	29	12	17	OR6.5 x1.5	
EW10L		10	M16x1.5	15	29	30	14	19	OR8x1.5	
EW12L		4560 psi	12	M18x1.5	17	29.5	32	17	22	OR10x1.5
EW15L		15	M22x1.5	21	32.5	36	19	27	OR12x2	
EW18L		18	M26x1.5	23.5	35.5	40	24	32	OR15x2	
EW22L	160 bar	22	M30 x2	27.5	38.5	44	27	36	OR20x2	
EW28L		28	M36 x2	30.5	41.5	47	36	41	OR26x2	
EW35L		2320psi	35	M45 x2	34.5	51	56	41	50	OR32x2.5
EW42L		42	M52 x2	40	56	63	50	60	OR38x2.5	
EW06S	S Heavy 630bar	6	M14x1.5	16	27	31	12	17	OR4.5x1.5	
EW08S		8	M16x1.5	17	27.5	32	14	19	OR6.5x1.5	
EW10S		10	M18x1.5	17.5	30	34	17	22	OR8x1.5	
EW12S		9130psi	12	M20x1.5	21.5	31	38	17	24	OR10x1.5
EW14S		14	M22x1.5	22	35	40	19	27	OR11x2	
EW16S		16	M24 x1.5	24.5	36.5	43	24	30	OR13x2	
EW20S	400 bar	20	M30 x2	26.5	44.5	48	27	36	OR16.3x2.4	
EW25S		5800 psi	25	M36 x2	30	50	54	36	46	OR20.3x2.4
EW30S		30	M42 x2	35.5	55	62	41	50	OR25.3x2.4	
EW38S	315 bar 4560 psi	38	M52 x2	41	63	72	50	60	OR33.3x2.4	

Swivel Nut Branch Tee Fitting - ET

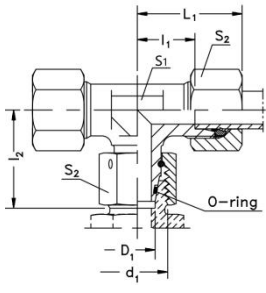

ET Part No.	Series Working Pressure (bar/psi)	Tube o.d.	d1 thread	I1	I2	L1	S1	S2	O-ring
ET06L	L Light 250 bar 4560 psi	6	M12 x1.5	12	26	27	12	14	OR4.5 x1.5
ET08L		8	M14x1.5	14	27.5	29	12	17	OR6.5 x1.5
ET10L		10	M16x1.5	15	29	30	14	19	OR8x1.5
ET12L		12	M18x1.5	17	29.5	32	17	22	OR10x1.5
ET15L		15	M22x1.5	21	32.5	36	19	27	OR12x2
ET18L		18	M26x1.5	23.5	35.5	40	24	32	OR15x2
ET22L	160 bar 2320psi	22	M30 x2	27.5	38.5	44	27	36	OR20x2
ET28L		28	M36 x2	30.5	41.5	47	36	41	OR26x2
ET35L		35	M45 x2	34.5	51	56	41	50	OR32x2.5
ET42L		42	M52 x2	40	56	63	50	60	OR38x2.5
ET06S	S Heavy 630bar 9130psi	6	M14x1.5	16	27	31	12	17	OR4.5x1.5
ET08S		8	M16x1.5	17	27.5	32	14	19	OR6.5x1.5
ET10S		10	M18x1.5	17.5	30	34	17	22	OR8x1.5
ET12S		12	M20x1.5	21.5	31	38	17	24	OR10x1.5
ET14S		14	M22x1.5	22	35	40	19	27	OR11x2
ET16S		400 bar 5800 psi	16	M24 x1.5	24.5	36.5	43	24	30
ET20S	20		M30 x2	26.5	44.5	48	27	36	OR16.3x2.4
ET25S	25		M36 x2	30	50	54	36	46	OR20.3x2.4
ET30S	30		M42 x2	35.5	55	62	41	50	OR25.3x2.4
ET38S	38		M52 x2	41	63	72	50	60	OR33.3x2.4

Swivel Nut Run Tee Fitting - EL

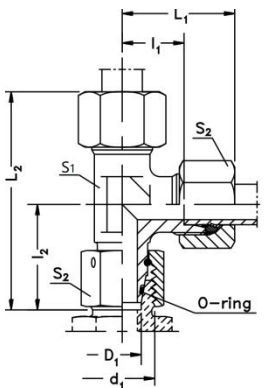

EL Part No.	Series Working Pressure (bar/psi)	Tube o.d.	d1 thread	I1	I2	L1	S1	S2	O-ring
EL06L	L Light 250 bar 4560 psi	6	M12 x1.5	12	26	27	53	14	OR4.5 x1.5
EL08L		8	M14x1.5	14	27.5	29	56	17	OR6.5 x1.5
EL10L		10	M16x1.5	15	29	30	59	19	OR8x1.5
EL12L		12	M18x1.5	17	29.5	32	61	22	OR10x1.5
EL15L		15	M22x1.5	21	32.5	36	69	27	OR12x2
EL18L		18	M26x1.5	23.5	35.5	40	75	32	OR15x2
EL22L	160 bar 2320psi	22	M30 x2	27.5	38.5	44	82	36	OR20x2
EL28L		28	M36 x2	30.5	41.5	47	89	41	OR26x2
EL35L		35	M45 x2	34.5	51	56	107	50	OR32x2.5
EL42L		42	M52 x2	40	56	63	119	60	OR38x2.5
EL06S	S Heavy 630bar 9130psi	6	M14x1.5	16	27	31	58	17	OR4.5x1.5
EL08S		8	M16x1.5	17	27.5	32	59	19	OR6.5x1.5
EL10S		10	M18x1.5	17.5	30	34	64	22	OR8x1.5
EL12S		12	M20x1.5	21.5	31	38	69	24	OR10x1.5
EL14S		14	M22x1.5	22	35	40	75	27	OR11x2
EL16S		400 bar 5800 psi	16	M24 x1.5	24.5	36.5	43	79	30
EL20S	20		M30 x2	26.5	44.5	48	93	36	OR16.3x2.4
EL25S	25		M36 x2	30	50	54	104	46	OR20.3x2.4
EL30S	30		M42 x2	35.5	55	62	117	50	OR25.3x2.4
EL38S	38		M52 x2	41	63	72	135	60	OR33.3x2.4

Assembled Adjustable Swivel Elbow - EW-R-ED

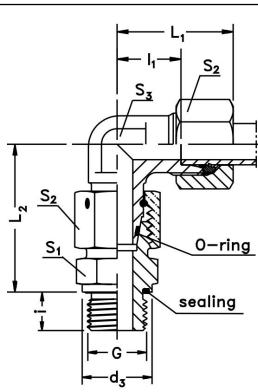

EW-M Part NO.	Series Working Pressure (bar/psi)	Tube O.d	G male thread	d3	i	l1	L1	L2	S1	S2	S3
EW06LRED	L Light 315 bar 4560 psi	6	G 1/8A	14	8	12	27	34.5	14	14	12
EW08LRED		8	G 1/4A	19	12	14	29	37.5	19	17	12
EW10LRED		10	G 1/4A	19	12	15	30	40	19	19	14
EW12LRED		12	G 3/8A	22	12	17	32	42	22	22	17
EW15LRED		15	G 1/2A	27	12	21	36	46.5	27	27	19
EW18LRED		18	G 1/2A	27	14	23.5	40	50	27	32	24
EW22LRED	160 bar 2320psi	22	G 3/4A	32	16	27.5	44	55	32	36	27
EW28LRED		28	G 1A	40	18	30.5	47	59	41	41	36
EW35LRED		35	G 1 1/4A	50	20	34.5	56	68.5	50	50	41
EW42LRED		42	G 1 1/2A	55	22	40	63	75	55	60	50
EW06SRED	S Heavy 630 bar 9130 psi	6	G 1/4A	19	12	16	31	40	19	17	12
EW08SRED		8	G 1/4A	19	12	17	32	42.5	19	19	14
EW10SRED		10	G 3/8A	22	12	17.5	34	45	22	22	17
EW12SRED		12	G 3/8A	22	12	21.5	38	48	22	24	17
EW14SRED		14	G 1/2A	27	14	22	40	54	27	27	19
EW16SRED		16	G 1/2A	27	14	24.5	43	55	27	30	24
EW20SRED	400 bar 5800 psi	20	G 3/4A	32	16	26.5	48	65	32	36	27
EW25SRED		25	G 1A	40	18	30	54	73	41	46	36
EW30SRED		30	G 1 1/4A	50	20	35.5	62	78.5	50	50	41
EW38SRED	315 bar 4560 psi	38	G 1 1/2A	55	22	41	72	89	55	60	50

Assembled Adjustable Swivel Elbow - EW-M-ED

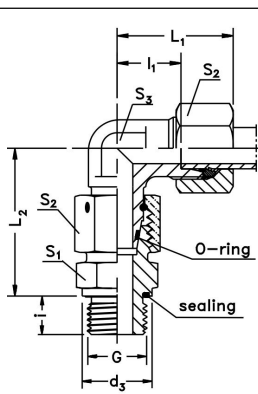

EW-M Part NO.	Series Working Pressure (bar/psi)	Tube O.d	G male thread	d3	i	l1	L1	L2	S1	S2	S3
EW06LMED	L Light 315 bar 4560 psi	6	M10 x1	14	8	12	27	34.5	14	14	12
EW08LMED		8	M12 x1.5	19	12	14	29	37.5	19	17	12
EW10LMED		10	M14x1.5	19	12	15	30	40	19	19	14
EW12LMED		12	M16x1.5	22	12	17	32	42	22	22	17
EW15LMED		15	M18x1.5	27	12	21	36	46.5	27	27	19
EW18LMED		18	M22x1.5	27	14	23.5	40	50	27	32	24
EW22LMED	160 bar 2320psi	22	M26x1.5	32	16	27.5	44	55	32	36	27
EW28LMED		28	M33x2	40	18	30.5	47	59	41	41	36
EW35LMED		35	M42x2	50	20	34.5	56	68.5	50	50	41
EW42LMED		42	M48x2	55	22	40	63	75	55	60	50
EW06SMED	S Heavy 630 bar 9130 psi	6	M12 x1.5	19	12	16	31	40	19	17	12
EW08SMED		8	M14x1.5	19	12	17	32	42.5	19	19	14
EW10SMED		10	M16x1.5	22	12	17.5	34	45	22	22	17
EW12SMED		12	M18x1.5	22	12	21.5	38	48	22	24	17
EW14SMED		14	M20x1.5	27	14	22	40	54	27	27	19
EW16SMED		16	M22x1.5	27	14	24.5	43	55	27	30	24
EW20SMED	400 bar 5800 psi	20	M27 x2	32	16	26.5	48	65	32	36	27
EW25SMED		25	M33x2	40	18	30	54	73	41	46	36
EW30SMED		30	M42x2	50	20	35.5	62	78.5	50	50	41
EW38SMED	315 bar 4560 psi	38	M48x2	55	22	41	72	89	55	60	50

Assembled Adjustable Swivel Branch Tee - ET-R-ED

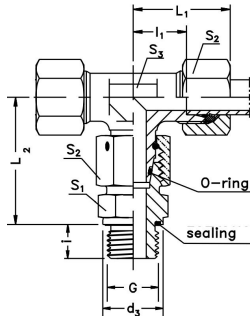

ET-M Part NO.	Series Working Pressure (bar/psi)	Tube O.d	G male thread	d3	i	l1	L1	L2	S1	S2	S3
ET06LRED	L Light 315 bar 4560 psi	6	G 1/8A	14	8	12	27	34.5	14	14	12
ET08LRED		8	G 1/4A	19	12	14	29	37.5	19	17	12
ET10LRED		10	G 1/4A	19	12	15	30	40	19	19	14
ET12LRED		12	G 3/8A	22	12	17	32	42	22	22	17
ET15LRED		15	G 1/2A	27	12	21	36	46.5	27	27	19
ET18LRED	160 bar 2320psi	18	G 1/2A	27	14	23.5	40	50	27	32	24
ET22LRED		22	G 3/4A	32	16	27.5	44	55	32	36	27
ET28LRED		28	G 1A	40	18	30.5	47	59	41	41	36
ET35LRED		35	G 1 1/4A	50	20	34.5	56	68.5	50	50	41
ET42LRED	S Heavy 630 bar 9130 psi	42	G 1 1/2A	55	22	40	63	75	55	60	50
ET06SRED		6	G 1/4A	19	12	16	31	40	19	17	12
ET08SRED		8	G 1/4A	19	12	17	32	42.5	19	19	14
ET10SRED		10	G 3/8A	22	12	17.5	34	45	22	22	17
ET12SRED		12	G 3/8A	22	12	21.5	38	48	22	24	17
ET14SRED		14	G 1/2A	27	14	22	40	54	27	27	19
ET16SRED		16	G 1/2A	27	14	24.5	43	55	27	30	24
ET20SRED		400 bar 5800 psi	20	G 3/4A	32	16	26.5	48	65	32	36
ET25SRED	25		G 1A	40	18	30	54	73	41	46	36
ET30SRED	30		G 1 1/4A	50	20	35.5	62	78.5	50	50	41
ET38SRED	315 bar 4560 psi	38	G 1 1/2A	55	22	41	72	89	55	60	50

Assembled Adjustable Swivel Branch Tee - ET-M-ED

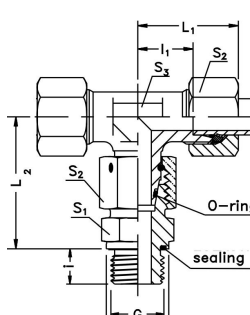

ET-M Part NO.	Series Working Pressure (bar/psi)	Tube O.d	G male thread	d3	i	l1	L1	L2	S1	S2	S3
ET06LMED	L Light 315 bar 4560 psi	6	M10 x1	14	8	12	27	34.5	14	14	12
ET08LMED		8	M12 x1.5	19	12	14	29	37.5	19	17	12
ET10LMED		10	M14x1.5	19	12	15	30	40	19	19	14
ET12LMED		12	M16x1.5	22	12	17	32	42	22	22	17
ET15LMED		15	M18x1.5	27	12	21	36	46.5	27	27	19
ET18LMED	160 bar 2320psi	18	M22x1.5	27	14	23.5	40	50	27	32	24
ET22LMED		22	M26x1.5	32	16	27.5	44	55	32	36	27
ET28LMED		28	M33x2	40	18	30.5	47	59	41	41	36
ET35LMED		35	M42x2	50	20	34.5	56	68.5	50	50	41
ET42LMED	S Heavy 630 bar 9130 psi	42	M48x2	55	22	40	63	75	55	60	50
ET06SMED		6	M12 x1.5	19	12	16	31	40	19	17	12
ET08SMED		8	M14x1.5	19	12	17	32	42.5	19	19	14
ET10SMED		10	M16x1.5	22	12	17.5	34	45	22	22	17
ET12SMED		12	M18x1.5	22	12	21.5	38	48	22	24	17
ET14SMED		14	M20x1.5	27	14	22	40	54	27	27	19
ET16SMED		16	M22x1.5	27	14	24.5	43	55	27	30	24
ET20SMED		400 bar 5800 psi	20	M27 x2	32	16	26.5	48	65	32	36
ET25SMED	25		M33x2	40	18	30	54	73	41	46	36
ET30SMED	30		M42x2	50	20	35.5	62	78.5	50	50	41
ET38SMED	315 bar 4560 psi	38	M48x2	55	22	41	72	89	55	60	50

Assembled Adjustable Swivel Run Tee - EL-R-ED

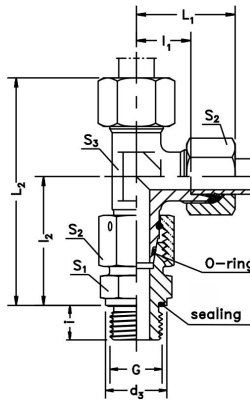

EL-M Part NO.	Series Working Pressure (bar/psi)	Tube O.d	G male thread	d3	i	l1	L1	L2	S1	S2	S3
EL06LRED	L Light 315 bar 4560 psi	6	G 1/8A	8	12	34.5	27	34.5	14	14	12
EL08LRED		8	G 1/4A	12	14	37.5	29	37.5	19	17	12
EL10LRED		10	G 1/4A	12	15	40	30	40	19	19	14
EL12LRED		12	G 3/8A	12	17	42	32	42	22	22	17
EL15LRED		15	G 1/2A	14	21	46.5	36	46.5	27	27	19
EL18LRED		18	G 1/2A	14	23.5	50	40	50	27	32	24
EL22LRED	160 bar 2320psi	22	G 3/4A	16	27.5	55	44	55	32	36	27
EL28LRED		28	G 1A	18	30.5	59	47	59	41	41	36
EL35LRED		35	G 1 1/4A	20	34.5	68.5	56	68.5	50	50	41
EL42LRED		42	G 1 1/2A	22	40	75	63	75	55	60	50
EL06SRED	S Heavy 630 bar 9130 psi	6	G 1/4A	12	16	40	31	40	19	17	12
EL08SRED		8	G 1/4A	12	17	42.5	32	42.5	19	19	14
EL10SRED		10	G 3/8A	12	17.5	45	34	45	22	22	17
EL12SRED		12	G 3/8A	12	21.5	48	38	48	22	24	17
EL14SRED		14	G 1/2A	14	22	54	40	54	27	27	19
EL16SRED		16	G 1/2A	14	24.5	55	43	55	27	30	24
EL20SRED	400 bar 5800 psi	20	G 3/4A	16	26.5	65	48	65	32	36	27
EL25SRED		25	G 1A	18	30	73	54	73	41	46	36
EL30SRED		30	G 1 1/4A	20	35.5	78.5	62	78.5	50	50	41
EL38SRED	315 bar 4560 psi	38	G 1 1/2A	22	41	89	72	89	55	60	50

Assembled Adjustable Swivel Run Tee - EL-M-ED

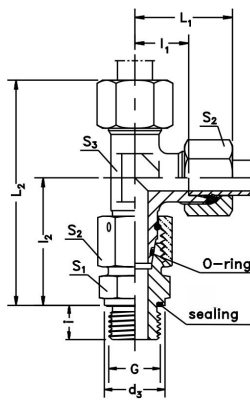

EL-M Part NO.	Series Working Pressure (bar/psi)	Tube O.d	G male thread	d3	i	l1	L1	L2	S1	S2	S3
EL06LMED	L Light 315 bar 4560 psi	6	M10 x1	14	8	12	27	34.5	14	14	12
EL08LMED		8	M12 x1.5	19	12	14	29	37.5	19	17	12
EL10LMED		10	M14x1.5	19	12	15	30	40	19	19	14
EL12LMED		12	M16x1.5	22	12	17	32	42	22	22	17
EL15LMED		15	M18x1.5	27	12	21	36	46.5	27	27	19
EL18LMED		18	M22x1.5	27	14	23.5	40	50	27	32	24
EL22LMED	160 bar 2320psi	22	M26x1.5	32	16	27.5	44	55	32	36	27
EL28LMED		28	M33x2	40	18	30.5	47	59	41	41	36
EL35LMED		35	M42x2	50	20	34.5	56	68.5	50	50	41
EL42LMED		42	M48x2	55	22	40	63	75	55	60	50
EL06SMED	S Heavy 630 bar 9130 psi	6	M12 x1.5	19	12	16	31	40	19	17	12
EL08SMED		8	M14x1.5	19	12	17	32	42.5	19	19	14
EL10SMED		10	M16x1.5	22	12	17.5	34	45	22	22	17
EL12SMED		12	M18x1.5	22	12	21.5	38	48	22	24	17
EL14SMED		14	M20x1.5	27	14	22	40	54	27	27	19
EL16SMED		16	M22x1.5	27	14	24.5	43	55	27	30	24
EL20SMED	400 bar 5800 psi	20	M27 x2	32	16	26.5	48	65	32	36	27
EL25SMED		25	M33x2	40	18	30	54	73	41	46	36
EL30SMED		30	M42x2	50	20	35.5	62	78.5	50	50	41
EL38SMED	315 bar 4560 psi	38	M48x2	55	22	41	72	89	55	60	50

Adjustable Lock Nut Branch Tee - TEE-M

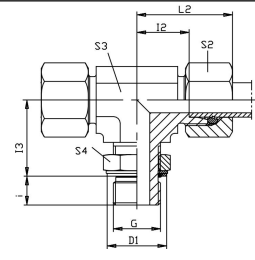

TEE-M Part NO.	Series Working Pressure (bar/psi)	Tube O.d	G male thread	L2	I2	I3	i	D1	S2	S3	S4
TEE06LM	315 bar 4560psi	6	M10x1	29	14	20	7	15	14	14	14
TEE08LM		8	M12x1.5	31	16	22	10	18	17	14	17
TEE10LM		10	M14x1.5	32	17	25	9	20	19	19	19
TEE12LM		12	M16x1.5	34	19	26	9	23	22	19	22
TEE15LM		15	M18x1.5	36	21	30	11	25	27	22	24
TEE18LM	250bar 3625psi	18	M22x1.5	40	24	33	11	28	32	27	27
TEE22LM	160 bar 2320psi	22	M27x2	44	28	35	14	33	36	30	32
TEE28LM		28	M33x2	47	31	38	14	41	41	36	41
TEE35LM		35	M42x2	59	38	48	14	51	50	50	50
TEE42LM		42	M48x2	61	38	49	16	56	60	50	55
TEE06SM	315 bar 4650psi	6	M12x1.5	30	15	22	10	18	17	14	17
TEE08SM		8	M14x1.5	32	17	26	10	20	19	19	19
TEE10SM		10	M16x1.5	34	18	27	11	23	22	19	22
TEE12SM		12	M18x1.5	38	22	31	12	25	24	22	24
TEE16SM	250bar	16	M22x1.5	43	25	35	14	28	30	27	27
TEE20SM	3625psi	20	M27x2	49	28	39	16	33	36	30	32
TEE25SM	160 bar 2320 psi	25	M33x2	54	30	44	16	41	46	36	41
TEE30SM		30	M42x2	62	36	51	17	51	50	50	50
TEE38SM		38	M48x2	65	34	54	19	56	60	50	55

Adjustable Lock Nut Branch Tee - TEE-R

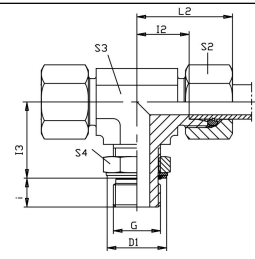

TEE-R Part NO.	Series Working Pressure (bar/psi)	Tube O.d	G male thread	L2	I2	I3	i	D1	S2	S3	S4
TEE06LR	315 bar 4560psi	6	G 1/8A	29	14	20	7	15	14	14	14
TEE08LR		8	G 1/4A	31	16	22	10	18	17	14	17
TEE10LR		10	G 1/4A	32	17	25	9	20	19	19	19
TEE12LR		12	G 3/8A	34	19	26	9	23	22	19	22
TEE15LR		15	G 1/2A	36	21	30	11	25	27	22	24
TEE18LR	250bar 3625psi	18	G 1/2A	40	24	33	11	28	32	27	27
TEE22LR	160 bar 2320psi	22	G 3/4A	44	28	35	14	33	36	30	32
TEE28LR		28	G1A	47	31	38	14	41	41	36	41
TEE35LR		35	G1 1/4 A	59	38	48	14	51	50	50	50
TEE42LR		42	G1 1/2 A	61	38	49	16	56	60	50	55
TEE06SR	315 bar 4650psi	6	G 1/4A	30	15	22	10	18	17	14	17
TEE08SR		8	G 1/4A	32	17	26	10	20	19	19	19
TEE10SR		10	G 3/8A	34	18	27	11	23	22	19	22
TEE12SR		12	G 3/8A	38	22	31	12	25	24	22	24
TEE16SR	250bar	16	G 1/2A	43	25	35	14	28	30	27	27
TEE20SR	3625psi	20	G 3/4A	49	28	39	16	33	36	30	32
TEE25SR	160 bar 2320 psi	25	G 1A	54	30	44	16	41	46	36	41
TEE30SR		30	G 1 1/4A	62	36	51	17	51	50	50	50
TEE38SR		38	G1 1/2A	65	34	54	19	56	60	50	55

Adjustable Lock Nut Branch Tee - TEE-UNF

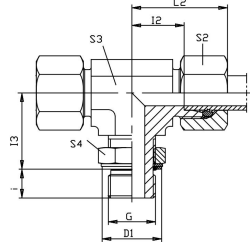

TEE-UNF Part NO.	Series Working Pressure (bar/psi)	Tube O.d	G male thread	L2	I2	I3	i	D1	S2	S3	S4
TEE06L7/16UNF	L light 315 bar 4560psi	6	7/16-20	29	14	19	10	17	14	14	14
TEE08L7/16UNF		8	7/16-20	31	16	19	10	18	17	14	14
TEE10L9/16UNF		10	9/16-18	32	17	24	10	20	19	19	17
TEE12L9/16UNF		12	9/16-18	34	19	25	11	26	22	19	17
TEE12L3/4UNF		12	3/4-16	34	19	25	13	26	22	19	22
TEE15L3/4UNF		15	3/4-16	36	21	28	13	29	27	22	22
TEE15L7/8UNF		15	7/8-14	36	21	28	15	29	27	22	27
TEE18L7/8UNF		18	7/8-14	40	24	32	15	29	32	27	27
TEE18L11/16UN		18	1 1/16-12	40	24	32	17	29	32	30	32
TEE22L11/16UN		22	1 1/16-12	44	28	35	17	37	36	30	32
TEE28L15/16UN	28	1 5/16-12	47	31	42	17	44	41	36	41	
TEE35L15/8UN	35	1 5/8-12	59	38	46	17	55	50	50	50	
TEE42L17/8UN	42	1 7/8-12	61	38	47	17	55	60	50	55	
TEE06S7/16UNF	S heavy 400 bar 5800psi	6	7/16-20	30	15	20	12	17	17	14	14
TEE08S9/16UNF		8	9/16-18	32	17	25	12	18	19	19	17
TEE10S9/16UNF		10	9/16-18	34	18	26	12	20	22	19	17
TEE12S3/4UNF		12	3/4-16	38	22	30	14	26	24	22	22
TEE16S7/8UNF		16	7/8-14	43	25	34	16	29	30	27	27
TEE20S11/16UN		20	1 1/16-12	49	28	37	19	37	36	30	32
TEE25S11/16UN		25	1 1/16-12	54	30	50	19	44	46	36	32
TEE30S15/8UN		30	1 5/8-12	62	36	50	19	55	50	50	50
TEE38S17/8UN	38	1 7/8-12	65	34	51	19	55	60	50	55	

Adjustable Lock Nut Elbow - WEE-M

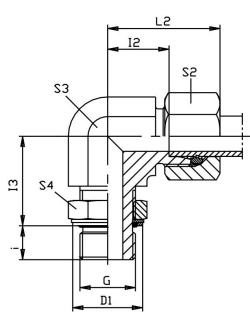

WEE-M Part NO.	Series Working Pressure (bar/psi)	Tube O.d	G male thread	L2	I2	I3	i	D1	S2	S3	S4
WEE06LM	L light 315 bar 4560psi	6	M10x1	29	14	20	7	15	14	14	14
WEE08LM		8	M12x1.5	31	16	22	10	18	17	14	17
WEE10LM		10	M14x1.5	32	17	25	9	20	19	19	19
WEE12LM		12	M16x1.5	34	19	26	9	23	22	19	22
WEE15LM		15	M18x1.5	36	21	30	11	25	27	22	24
WEE18LM	18	M22x1.5	40	24	33	11	28	32	27	27	
WEE22LM	22	M27x2	44	28	35	14	33	36	30	32	
WEE28LM	28	M33x2	47	31	38	14	41	41	36	41	
WEE35LM	35	M42x2	59	38	48	14	51	50	50	50	
WEE42LM	42	M48x2	61	38	49	16	56	60	50	55	
WEE06SM	S heavy 315 bar 4650psi	6	M12x1.5	30	15	22	10	18	17	14	17
WEE08SM		8	M14x1.5	32	17	26	10	20	19	19	19
WEE10SM		10	M16x1.5	34	18	27	11	23	22	19	22
WEE12SM		12	M18x1.5	38	22	31	12	25	24	22	24
WEE16SM	16	M22x1.5	43	25	35	14	28	30	27	27	
WEE20SM	20	M27x2	49	28	39	16	33	36	30	32	
WEE25SM	25	M33x2	54	30	44	16	41	46	36	41	
WEE30SM	30	M42x2	62	36	51	17	51	50	50	50	
WEE38SM	38	M48x2	65	34	54	19	56	60	50	55	

Adjustable Lock Nut Elbow - WEE-R

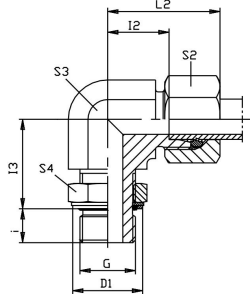

WEE-R Part NO.	Series Working Pressure (bar/psi)	Tube O.d	G male thread	L2	I2	I3	i	D1	S2	S3	S4
WEE06LR	L light 315 bar 4560psi	6	G 1/8A	29	14	20	7	15	14	14	14
WEE08LR		8	G 1/4A	31	16	22	10	18	17	14	17
WEE10LR		10	G 1/4A	32	17	25	9	20	19	19	19
WEE12LR		12	G 3/8A	34	19	26	9	23	22	19	22
WEE15LR		15	G 1/2A	36	21	30	11	25	27	22	24
WEE18LR	250bar 3625psi	18	G 1/2A	40	24	33	11	28	32	27	27
WEE22LR	160 bar 2320psi	22	G 3/4A	44	28	35	14	33	36	30	32
WEE28LR		28	G1A	47	31	38	14	41	41	36	41
WEE35LR		35	G1 1/4 A	59	38	48	14	51	50	50	50
WEE42LR		42	G1 1/2 A	61	38	49	16	56	60	50	55
WEE06SR		S heavy 315 bar 4650psi	6	G 1/4A	30	15	22	10	18	17	14
WEE08SR	8		G 1/4A	32	17	26	10	20	19	19	19
WEE10SR	10		G 3/8A	34	18	27	11	23	22	19	22
WEE12SR	12		G 3/8A	38	22	31	12	25	24	22	24
WEE16SR	250bar 3625psi		16	G 1/2A	43	25	35	14	28	30	27
WEE20SR	160 bar 2320 psi	20	G 3/4A	49	28	39	16	33	36	30	32
WEE25SR		25	G 1A	54	30	44	16	41	46	36	41
WEE30SR		30	G 1 1/4A	62	36	51	17	51	50	50	50
WEE38SR		38	G1 1/2A	65	34	54	19	56	60	50	55

Adjustable Lock Nut Elbow - WEE-UNF

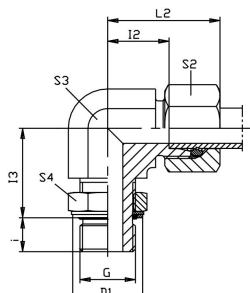

WEE-UNF Part NO.	Series Working Pressure (bar/psi)	Tube O.d	G male thread	L2	I2	I3	i	D1	S2	S3	S4
WEE06L7/16UNF	L light 315 bar 4560psi	6	7/16-20	29	14	19	10	17	14	14	14
WEE08L7/16UNF		8	7/16-20	31	16	19	10	18	17	14	14
WEE10L9/16UNF		10	9/16-18	32	17	24	10	20	19	19	17
WEE12L9/16UNF		12	9/16-18	34	19	25	11	26	22	19	17
WEE12L3/4UNF		12	3/4-16	34	19	25	13	26	22	19	22
WEE15L3/4UNF		15	3/4-16	36	21	28	13	29	27	22	22
WEE15L7/8UNF		15	7/8-14	36	21	28	15	29	27	22	27
WEE18L7/8UNF		18	7/8-14	40	24	32	15	29	32	27	27
WEE18L11/16UN		18	1 1/16-12	40	24	32	17	29	32	30	32
WEE22L11/16UN		160 bar 2320psi	22	1 1/16-12	44	28	35	17	37	36	30
WEE28L15/16UN	28		1 5/16-12	47	31	42	17	44	41	36	41
WEE35L15/8UN	35		1 5/8-12	59	38	46	17	55	50	50	50
WEE42L17/8UN	42		1 7/8-12	61	38	47	17	55	60	50	55
WEE06S7/16UNF	S heavy 400 bar 5800psi		6	7/16-20	30	15	20	12	17	17	14
WEE08S9/16UNF		8	9/16-18	32	17	25	12	18	19	19	17
WEE10S9/16UNF		10	9/16-18	34	18	26	12	20	22	19	17
WEE12S3/4UNF		12	3/4-16	38	22	30	14	26	24	22	22
WEE16S7/8UNF		16	7/8-14	43	25	34	16	29	30	27	27
WEE20S11/16UN		20	1 1/16-12	49	28	37	19	37	36	30	32
WEE25S11/16UN		25	1 1/16-12	54	30	50	19	44	46	36	32
WEE30S15/8UN		250bar	30	1 5/8-12	62	36	50	19	55	50	50
WEE38S17/8UN	3625psi	38	1 7/8-12	65	34	51	19	55	60	50	

Adjustable Lock Nut Run Tee - LEE-M

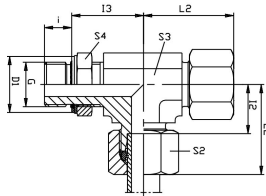

LEE-M Part NO.	Series Working Pressure (bar/psi)	Tube O.d	G male thread	L2	I2	I3	i	D1	S2	S3	S4
LEE06LM	L light 315 bar 4560psi	6	M10x1	29	14	20	7	15	14	14	14
LEE08LM		8	M12x1.5	31	16	22	10	18	17	14	17
LEE10LM		10	M14x1.5	32	17	25	9	20	19	19	19
LEE12LM		12	M16x1.5	34	19	26	9	23	22	19	22
LEE15LM		15	M18x1.5	36	21	30	11	25	27	22	24
LEE18LM	250bar 3625psi	18	M22x1.5	40	24	33	11	28	32	27	27
LEE22LM	160 bar 2320psi	22	M27x2	44	28	35	14	33	36	30	32
LEE28LM		28	M33x2	47	31	38	14	41	41	36	41
LEE35LM		35	M42x2	59	38	48	14	51	50	50	50
LEE42LM		42	M48x2	61	38	49	16	56	60	50	55
LEE06SM		S heavy 315 bar 4650psi	6	M12x1.5	30	15	22	10	18	17	14
LEE08SM	8		M14x1.5	32	17	26	10	20	19	19	19
LEE10SM	10		M16x1.5	34	18	27	11	23	22	19	22
LEE12SM	12		M18x1.5	38	22	31	12	25	24	22	24
LEE16SM	250bar 3625psi		16	M22x1.5	43	25	35	14	28	30	27
LEE20SM	160 bar 2320 psi	20	M27x2	49	28	39	16	33	36	30	32
LEE25SM		25	M33x2	54	30	44	16	41	46	36	41
LEE30SM		30	M42x2	62	36	51	17	51	50	50	50
LEE38SM		38	M48x2	65	34	54	19	56	60	50	55

Adjustable Lock NutRun Tee - LEE-R

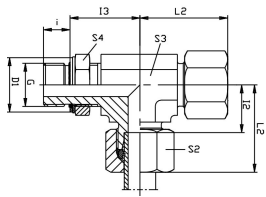

LEE-R Part NO.	Series Working Pressure (bar/psi)	Tube O.d	G male thread	L2	I2	I3	i	D1	S2	S3	S4
LEE06LR	L light 315 bar 4560psi	6	G 1/8A	29	14	20	7	15	14	14	14
LEE08LR		8	G 1/4A	31	16	22	10	18	17	14	17
LEE10LR		10	G 1/4A	32	17	25	9	20	19	19	19
LEE12LR		12	G 3/8A	34	19	26	9	23	22	19	22
LEE15LR		15	G 1/2A	36	21	30	11	25	27	22	24
LEE18LR	250bar 3625psi	18	G 1/2A	40	24	33	11	28	32	27	27
LEE22LR	160 bar 2320psi	22	G 3/4A	44	28	35	14	33	36	30	32
LEE28LR		28	G1A	47	31	38	14	41	41	36	41
LEE35LR		35	G1 1/4 A	59	38	48	14	51	50	50	50
LEE42LR		42	G1 1/2 A	61	38	49	16	56	60	50	55
LEE06SR		S heavy 315 bar 4650psi	6	G 1/4A	30	15	22	10	18	17	14
LEE08SR	8		G 1/4A	32	17	26	10	20	19	19	19
LEE10SR	10		G 3/8A	34	18	27	11	23	22	19	22
LEE12SR	12		G 3/8A	38	22	31	12	25	24	22	24
LEE16SR	250bar 3625psi		16	G 1/2A	43	25	35	14	28	30	27
LEE20SR	160 bar 2320 psi	20	G 3/4A	49	28	39	16	33	36	30	32
LEE25SR		25	G 1A	54	30	44	16	41	46	36	41
LEE30SR		30	G 1 1/4A	62	36	51	17	51	50	50	50
LEE38SR		38	G1 1/2A	65	34	54	19	56	60	50	55

Adjustable Lock Nut Run Tee - LEE-UNF

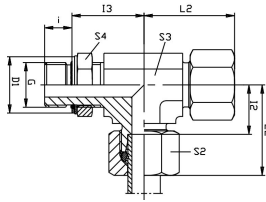

LEE-UNF Part NO.	Series Working Pressure (bar/psi)	Tube O.d	G male thread	L2	I2	I3	i	D1	S2	S3	S4
LEE06L7/16UNF	L light 315 bar 4560psi	6	7/16-20	29	14	19	10	17	14	14	14
LEE08L7/16UNF		8	7/16-20	31	16	19	10	18	17	14	14
LEE10L9/16UNF		10	9/16-18	32	17	24	10	20	19	19	17
LEE12L9/16UNF		12	9/16-18	34	19	25	11	26	22	19	17
LEE12L3/4UNF		12	3/4-16	34	19	25	13	26	22	19	22
LEE15L3/4UNF		15	3/4-16	36	21	28	13	29	27	22	22
LEE15L7/8UNF		15	7/8-14	36	21	28	15	29	27	22	27
LEE18L7/8UNF		18	7/8-14	40	24	32	15	29	32	27	27
LEE18L11/16UN		18	1 1/16-12	40	24	32	17	29	32	30	32
LEE22L11/16UN	160 bar 2320psi	22	1 1/16-12	44	28	35	17	37	36	30	32
LEE28L15/16UN		28	1 5/16-12	47	31	42	17	44	41	36	41
LEE35L15/8UN		35	1 5/8-12	59	38	46	17	55	50	50	50
LEE42L17/8UN		42	1 7/8-12	61	38	47	17	55	60	50	55
LEE06S7/16UNF	S heavy 400 bar 5800psi	6	7/16-20	30	15	20	12	17	17	14	14
LEE08S9/16UNF		8	9/16-18	32	17	25	12	18	19	19	17
LEE10S9/16UNF		10	9/16-18	34	18	26	12	20	22	19	17
LEE12S3/4UNF		12	3/4-16	38	22	30	14	26	24	22	22
LEE16S7/8UNF		16	7/8-14	43	25	34	16	29	30	27	27
LEE20S11/16UN		20	1 1/16-12	49	28	37	19	37	36	30	32
LEE25S11/16UN		25	1 1/16-12	54	30	50	19	44	46	36	32
LEE30S15/8UN		250bar	30	1 5/8-12	62	36	50	19	55	50	50
LEE38S17/8UN	3625psi	38	1 7/8-12	65	34	51	19	55	60	50	55

Adjustable Lock Nut 45° Elbow - VEE-M

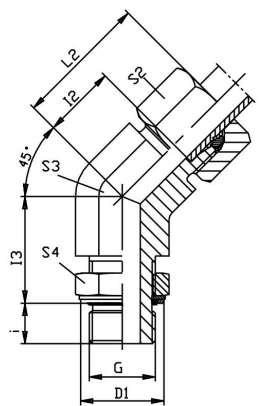

VEE-M Part NO.	Series Working Pressure (bar/psi)	Tube O.d	G male thread	L2	I2	I3	i	D1	S2	S3	S4
VEE06LM	L light 315 bar 4560psi	6	M10x1	24	9	21	7	15	14	14	14
VEE08LM		8	M12x1.5	27	12	19	10	18	17	14	17
VEE10LM		10	M14x1.5	27	12	24	9	20	19	19	19
VEE12LM		12	M16x1.5	28	14	25	9	23	22	19	22
VEE15LM		15	M18x1.5	32	17	24	11	25	27	22	24
VEE18LM		250bar 3625psi	18	M22x1.5	33	17	31	11	28	32	27
VEE22LM	160 bar 2320psi	22	M27x2	35	19	31	14	33	36	30	32
VEE28LM		28	M33x2	40	23	35	14	41	41	36	41
VEE35LM		35	M42x2	48	27	37	14	51	50	50	50
VEE42LM		42	M48x2	49	26	37	16	56	60	50	55
VEE06SM	S heavy 315 bar 4650psi	6	M12x1.5	24	9	19	10	18	17	14	17
VEE08SM		8	M14x1.5	27	12	19	10	20	19	19	19
VEE10SM		10	M16x1.5	29	13	23	11	23	22	19	22
VEE12SM		12	M18x1.5	33	17	25	12	25	24	22	24
VEE16SM	250bar	16	M22x1.5	34	16	30	14	28	30	27	27
VEE20SM	3625psi	20	M27x2	38	16	35	16	33	36	30	32
VEE25SM	160 bar	25	M33x2	43	19	37	16	41	46	36	41
VEE30SM	2320 psi	30	M42x2	50	24	37	17	51	50	50	50
VEE38SM		38	M48x2	50	9	38	19	56	60	50	55

Adjustable Lock Nut 45° Elbow - VEE-R

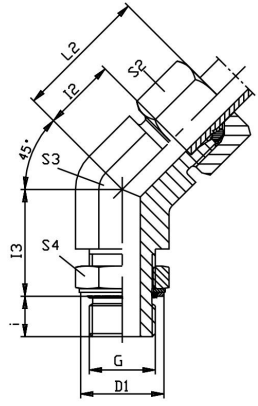

VEE-R Part NO.	Series Working Pressure (bar/psi)	Tube O.d	G male thread	L2	I2	I3	i	D1	S2	S3	S4
VEE06LR	L light 315 bar 4560psi	6	G 1/8A	24	9	21	7	15	14	14	14
VEE08LR		8	G 1/4A	27	12	19	10	18	17	14	17
VEE10LR		10	G 1/4A	27	12	24	9	20	19	19	19
VEE12LR		12	G3/8A	28	14	25	9	23	22	19	22
VEE15LR		15	G1/2A	32	17	24	11	25	27	22	24
VEE18LR	250bar 3625psi	18	G1/2A	33	17	31	11	28	32	27	27
VEE22LR	160 bar 2320psi	22	G 3/4A	35	19	31	14	33	36	30	32
VEE28LR		28	G 1A	40	23	35	14	41	41	36	41
VEE35LR		35	G11/4A	48	27	37	14	51	50	50	50
VEE42LR		42	G11/2A	49	26	37	16	56	60	50	55
VEE06SR	S heavy 315 bar 4650psi	6	G 1/4A	24	9	19	10	18	17	14	17
VEE08SR		8	G 1/4A	27	12	19	10	20	19	19	19
VEE10SR		10	G 3/8A	29	13	23	11	23	22	19	22
VEE12SR		12	G 3/8A	33	17	25	12	25	24	22	24
VEE16SR	250bar	16	G1/2A	34	16	30	14	28	30	27	27
VEE20SR	3625psi	20	G 3/4A	38	16	35	16	33	36	30	32
VEE25SR	160 bar	25	G 1A	43	19	37	16	41	46	36	41
VEE30SR	2320 psi	30	G11/4A	50	24	37	17	51	50	50	50
VEE38LR		38	G11/2A	50	9	38	19	56	60	50	55

Adjustable Lock Nut 45° Elbow - VEE-UNF

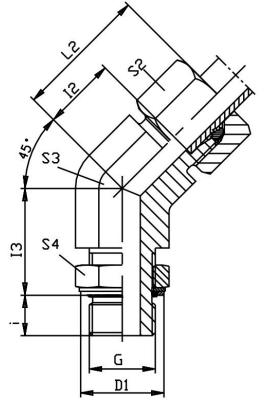

VEE-UNF Part NO.	Series Working Pressure (bar/psi)	Tube O.d	G male thread	L2	I2	I3	i	D1	S2	S3	S4
VEE06L7/16UNF	L light 315 bar 4560psi	6	7/16-20	29	14	19	10	17	14	14	14
VEE08L7/16UNF		8	7/16-20	31	16	19	10	18	17	14	14
VEE10L7/16UNF		10	9/16-18	32	17	24	10	20	19	19	17
VEE12L9/16UNF		12	9/16-18	34	19	25	11	26	22	19	17
VEE12L3/4UNF		12	3/4-16	34	19	25	13	26	22	19	22
VEE15L3/4UNF		15	3/4-16	36	21	28	13	29	27	22	22
VEE15L7/8UNF		15	7/8-14	36	21	28	15	29	27	22	27
VEE18L7/8UNF		18	7/8-14	40	24	32	15	29	32	27	27
VEE18L11/16UN		18	1 1/16-12	40	24	32	17	29	32	30	32
VEE22L11/16UN	160 bar 2320psi	22	1 1/16-12	44	28	35	17	37	36	30	32
VEE28L15/16UN		28	1 5/16-12	47	31	42	17	44	41	36	41
VEE35L15/8UN		35	1 5/8-12	59	38	46	17	55	50	50	50
VEE42L17/8UN	42	1 7/8-12	61	38	47	17	55	60	50	55	
VEE06S7/16UNF	S heavy 400 bar 5800psi	6	7/16-20	30	15	20	12	17	17	14	14
VEE08S9/16UNF		8	9/16-18	32	17	25	12	18	19	19	17
VEE10S9/16UNF		10	9/16-18	34	18	26	12	20	22	19	17
VEE12S3/4UNF		12	3/4-16	38	22	30	14	26	24	22	22
VEE16S7/8UNF		16	7/8-14	43	25	34	16	29	30	27	27
VEE20S11/16UN		20	1 1/16-12	49	28	37	19	37	36	30	32
VEE25S11/16UN		25	1 1/16-12	54	30	50	19	44	46	36	32
VEE30S15/8UN		250bar	30	1 5/8-12	62	36	50	19	55	50	50
VEE38S17/8UN		3625psi	38	1 7/8-12	65	34	51	19	55	60	50

Swivel Connector - EGE-R-ED

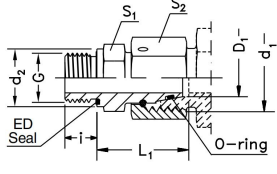

EGE-R-ED Part NO.	Series Working Pressure (bar/psi)	D1 Tube o.d.	G male thread BSPP	d1	d2	i	L1	S1	S2
EGE06LRED	L light 315 bar 4560 psi	6	G 1/8A	M12 x1.5	14	8	24.5	14	14
EGE08LRED		8	G 1/4A	M14x1.5	19	12	29.5	19	17
EGE10LRED		10	G 1/4A	M16x1.5	19	12	27.5	19	19
EGE12LRED		12	G3/8A	M18x1.5	22	12	34	22	22
EGE15LRED		15	G1/2A	M22x1.5	27	14	32	27	27
EGE18LRED		18	G1/2A	M26x1.5	27	14	31.5	27	32
EGE22LRED	160 bar 2320 psi	22	G 3/4A	M30 x2	32	16	32.5	32	36
EGE28LRED		28	G 1A	M36 x2	40	18	35	41	41
EGE35LRED		35	G11/4A	M45 x2	50	20	42.5	50	50
EGE42LRED		42	G11/2A	M52 x2	55	22	46.5	55	60
EGE06SRED	S heavy 630 bar 9130 psi	6	G 1/4A	M14x1.5	19	12	27	19	17
EGE08SRED		8	G 1/4A	M16x1.5	19	12	29.5	19	19
EGE10SRED		10	G 3/8A	M18x1.5	22	12	32	22	22
EGE12SRED		12	G 3/8A	M20x1.5	22	12	34	22	24
EGE14SRED		14	G1/2A	M22x1.5	27	14	36.5	27	27
EGE16SRED		400 bar 5800 psi	16	G1/2A	M24 x1.5	27	14	37	27
EGE20SRED	20		G 3/4A	M30 x2	32	16	43	32	36
EGE25SRED	25		G 1A	M36 x2	40	51	48	41	46
EGE30SRED	30		G11/4A	M42 x2	50	20	51	50	50
EGE38SRED	38		G11/2A	M52 x2	55	22	60	55	60

Swivel Connector - EGE-M-ED

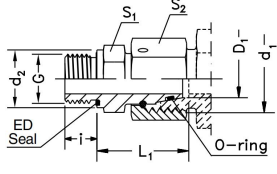

EGE-M-ED Part NO.	Series Working Pressure (bar/psi)	D1 Tube o.d.	G male thread BSPP	d1	d2	i	L1	S1	S2
EGE06LRED	L light 315 bar 4560 psi	6	M10x1	M12 x1.5	14	8	24.5	14	14
EGE08LRED		8	M12x1.5	M14x1.5	19	12	29.5	19	17
EGE10LRED		10	M14x1.5	M16x1.5	19	12	27.5	19	19
EGE12LRED		12	M16x1.5	M18x1.5	22	12	34	22	22
EGE15LRED		15	M18x1.5	M22x1.5	27	14	32	27	27
EGE18LRED		18	M22x1.5	M26x1.5	27	14	31.5	27	32
EGE22LRED	160 bar 2320 psi	22	M26x1.5	M30 x2	32	16	32.5	32	36
EGE28LRED		28	M33x2	M36 x2	40	18	35	41	41
EGE35LRED		35	M42x2	M45 x2	50	20	42.5	50	50
EGE42LRED		42	M48x2	M52 x2	55	22	46.5	55	60
EGE06SRED	S heavy 630 bar 9130 psi	6	M12x1.5	M14x1.5	19	12	27	19	17
EGE08SRED		8	M14x1.5	M16x1.5	19	12	29.5	19	19
EGE10SRED		10	M16x1.5	M18x1.5	22	12	32	22	22
EGE12SRED		12	M18x1.5	M20x1.5	22	12	34	22	24
EGE14SRED		14	M20x1.5	M22x1.5	27	14	36.5	27	27
EGE16SRED		400 bar 5800 psi	16	M22x1.5	M24 x1.5	27	14	37	27
EGE20SRED	20		M27x2	M30 x2	32	16	43	32	36
EGE25SRED	25		M33x2	M36 x2	40	51	48	41	46
EGE30SRED	30		M42x2	M42 x2	50	20	51	50	50
EGE38SRED	38		M48x2	M52 x2	55	22	60	55	60

Swivel Connector - EGE-NPT

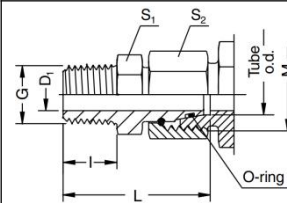

EGE-NPT Part NO.	Series Working Pressure (bar/psi)	Tube o.d.	M	G male thread	D1	i	L	S1	S2
EGE06L1/8NPT	L light 315 bar 4560 psi	6	M12x1.5	1/8 NPT	2.5	10	31.5	11	14
EGE08L1/4NPT		8	M14x1.5	1/4 NPT	4	15	37.5	14	17
EGE10L1/4NPT		10	M16x1.5	1/4 NPT	6	15	38	14	19
EGE12L3/8NPT		12	M18x1.5	3/8 NPT	8	15.3	40	19	22
EGE15L1/2NPT		15	M22x1.5	1/2 NPT	10	20	49.5	22	27
EGE18L1/2NPT		18	M26x1.5	1/2 NPT	12	20	49	24	32
EGE22L3/4NPT	160 bar 2320 psi	22	M30 x 2	3/4 NPT	16	20	52	27	36
EGE28L1NPT		28	M36 x 2	1- NPT	22	25	61	36	41
EGE35L11/4NPT		35	M45 x 2	1 1/4NPT	28	25.5	65.5	46	50
EGE42L11/2NPT		42	M52 x 2	1 1/2NPT	34	26	68.5	50	60
EGE06S1/4NPT	S heavy 630 bar 9130 psi	6	M14x1.5	1/4 NPT	2.5	15	37.5	14	17
EGE08S1/4NPT		8	M16x1.5	1/4 NPT	4	15	38	14	19
EGE10S3/8NPT		10	M18x1.5	3/8 NPT	6	15.3	40.5	19	22
EGE12S3/8NPT		12	M20x1.5	1/2 NPT	8	15.3	42	19	24
EGE14S1/2NPT		14	M22x1.5	1/2 NPT	9	20	50.5	22	27
EGE16S1/2NPT		16	M24x1.5	1/2 NPT	11	20	51	24	30
EGE20S3/4NPT	400 bar 5800 psi	20	M30 x 2	3/4 NPT	14	20	54	27	36
EGE25S1NPT		25	M36 x 2	1- NPT	18	25	63.5	36	46
EGE30S11/4NPT		30	M42 x 2	1 1/4NPT	23	25.5	70.5	46	50
EGE38S11/2NPT	315 bar 4560 psi	38	M52 x 2	1 1/2NPT	30	26	73.5	50	60

Swivel Union - GZ

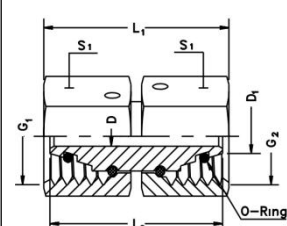

GZ Part no.	Series Working Pressure (bar/psi)	D1 Tube o.d.	G1, G2 Metric Thread	L1	L2	S1	D
GZ06L	L light 315 bar 4570 psi	6	M12x1.5	33	32	14	2.5
GZ08L		8	M14x1.5	33	32	17	4
GZ10L		10	M16x1.5	34	33	19	6
GZ12L		12	M18x1.5	34	33	22	8
GZ15L		15	M22x1.5	39	38	27	10
GZ18L		18	M26x1.5	38	36	32	13
GZ22L	160 bar 2320 psi	22	M30x2	44	42	36	17
GZ28L		28	M36x2	48	46	41	22
GZ35L		35	M45x2	52	48	50	28
GZ42L		42	M52x2	57	52	60	34
GZ06S	S heavy 630 bar 9135 psi	6	M14x1.5	33	32	17	2.5
GZ08S		8	M16x1.5	34	33	19	4
GZ10S		10	M18x1.5	35	33	22	6
GZ12S		12	M20x1.5	38	36	24	8
GZ14S		14	M22x1.5	41	39	27	9
GZ16S		400 bar 5800 psi	16	M24x1.5	42	39	30
GZ20S	20		M30x2	48	44	36	14
GZ25S	25		M36x2	53	46	46	18
GZ30S	30		M42x2	62	52	50	23
GZ38S	315 bar 4570 psi	38	M52x2	67	52	60	30

Swivel Connector - EGEO

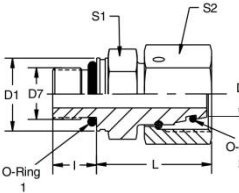

EGEO Part no.	Series Working Pressure (bar/psi)	D Tube o.d.	D7 Metric Thread	D1	I	L	S1	S2
EGEO06LM	315 bar 4560 psi	6	M12x1.5	13.8	8.5	24.5	14	14
EGEO08LM		8	M14x1.5	16.8	11.0	26.5	17	17
EGEO10LM		10	M16x1.5	18.8	11.0	27.5	19	19
EGEO12LM		12	M18x1.5	21.8	11.5	30.5	22	22
EGEO15LM		15	M22x1.5	23.8	12.5	31.5	24	27
EGEO18LM		18	M26x1.5	26.8	13.0	31.5	27	32
EGEO22LM	160 bar	22	M30x2	31.8	16.0	32.5	32	36
EGEO28LM	2320 psi	28	M36x2	40.8	16.0	35	41	41
EGEO35LM		35	M45x2	49.8	16.0	42.5	50	50
EGEO08SM	S heavy 630 bar 9130 psi	8	M16x1.5	18.8	11.0	29.5	19	19
EGEO10SM		10	M18x1.5	21.8	12.5	32	22	22
EGEO12SM		12	M20x1.5	23.8	14.0	34	24	24
EGEO16SM	400 bar	16	M24x1.5	26.8	15.0	37	27	30
EGEO20SM	5800 psi	20	M30x2	31.8	18.5	43	32	36
EGEO25SM		25	M36x2	40.8	18.5	48	41	46
EGEO30SM		30	M42x2	49.8	19.0	51	50	50

Swivel Union - GZR

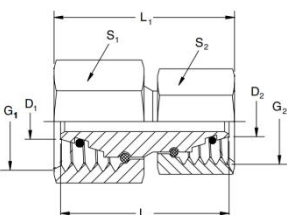

GZR Part no.	Series Working Pressure (bar/psi)	Tube o.d.		Metric Thread		L1	L2	S1	S2
		D1	D2	G1	G2				
GZR06L/06S	L light 315 bar 4565 psi	6	6	M14X1.5	M12X1.5	33	32	17	14
GZR08L/08S		8	8	M16X1.5	M14X1.5	34	33	19	17
GZR10L/10S		10	10	M18X1.5	M16X1.5	34.5	33	22	19
GZR12L/12S		12	12	M20X1.5	M18X1.5	37.5	36	24	22
GZR18L/16S		18	16	M26X1.5	M24X1.5	41.5	39	32	30
GZR22L/20S	160 bar	22	20	M30X2	M30X2	47	44	36	36
GZR28L/25S	2320 psi	28	25	M36X2	M36X2	50.5	46	41	46
GZR35L/30S		35	30	M45X2	M42X2	59	52	50	50
GZR42L/38S		42	38	M52X2	M52X2	62	52	60	60
GZR16S/15L	S heavy 315 bar 4565 psi	16	15	M24X1.5	M22X1.5	41	39	30	27
GZR20S/18L		20	18	M30X2	M26X1.5	47	44	36	32
GZR25S/22L	160 bar	25	22	M36X2	M30X2	50.5	46	46	36
GZR30S/28L	2320 psi	30	28	M42X2	M36X2	58	52	50	41
GZR38S/35L		38	35	M52X2	M45X2	61.5	52	60	50

Weld Nipple - SKA

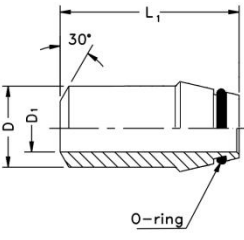
	SKA Part no.	Series Working Pressure (bar/psi)		D Tube o.d.	O-ring	D	D1	L	L1
	SKA10x1	249	3610	10x1	8x1.5	10	8	33.5	32.5
SKA10x1.5	358	5190	10x1.5	7					
SKA10x2	460	6670	10x2	6					
SKA12x1.5	305	4420	12x1.5	10x1.5	12	9	33.5	32.5	
SKA12x2	393	5700	12x2			8			
SKA12x2.5	476	6900	12x2.5			7			
SKA16x1.5	234	3400	16x1.5	13x2	16	13	40.5	39	
SKA16x2	305	4420	16x2			12			
SKA16x2.5	372	5400	16x2.5			11			
SKA16x3	435	6310	16x3			10			
SKA20x2	249	3610	20x2	16.3x24	20	16	47	45	
SKA20x2.5	305	4420	20x2.5			15			
SKA20x3	358	5190	20x3			14			
SKA20x4	460	6670	20x4			12			
SKA25x3	294	4260	25x3	20.3x2.4	25	19	53	49.5	
SKA25x4	379	5500	25x4			17			
SKA25x5	460	6670	25x5			15			
SKA30x3	249	3610	30x3	25.3x2.4	30	24	57	52	
SKA30x4	323	4680	30x4			22			
SKA30x5	393	5700	30x5			20			
SKA30x6	460	6670	30x6			18			
SKA38x4	261	3785	38x4	33.3x2.4	38	30	64	56.5	
SKA38x5	319	4625	38x5			28			
SKA38x6	375	5440	38x6			26			
SKA38x7	429	6220	38x7			24			

Nut - M

Cutting Lock Ring - D / Progressive Ring - DPR

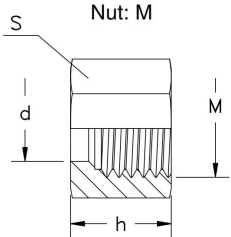
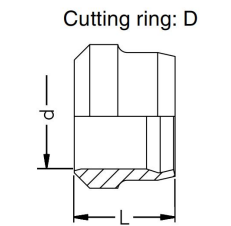
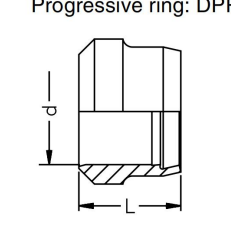
	Nut Part No.	Series	d Tube o.d.	M	S	h	L	Cutting ring and Progressive ring Part No.
	M04LL	LL Very light	4	M8 x 1	10	11	6	D04LL
	M06LL		6	M10x1	12	11.5	7	D06LL
	M08LL		8	M12x1	14	13	7	D08LL
	M10LL		10	M14x1	17	13	7	D10LL
	M12LL		12	M16x1	19	13	7.5	D12LL
	M06L	L light	6	M12x1.5	14	15	9.5	DPR06L
	M08L		8	M14x1.5	17	15	9.5	DPR08L
	M10L		10	M16x1.5	19	16	10.5	DPR10L
	M12L		12	M18x1.5	22	16	10	DPR12L
	M15L		15	M22x1.5	27	17.5	10	DPR15L
	M18L		18	M26x1.5	32	18.5	10	DPR18L
	M22L		22	M30x2	36	20.5	10.5	DPR22L
	M28L		28	M36x2	41	21	10.5	DPR28L
M35L	35	M45x2	50	24	13.5	DPR35L		
	M42L	42	M52x2	60	24	13.5	DPR42L	
	M06S	S heavy	6	M12x1.5	17	17	9.5	DPR06S
	M08S		8	M14x1.5	19	17	9.5	DPR08S
	M10S		10	M16x1.5	22	18	10	DPR10S
	M12S		12	M18x1.5	24	18	10	DPR12S
	M14S		14	M22x1.5	27	21	10	DPR14S
	M16S		16	M24x1.5	30	21	10.5	DPR16S
	M20S		20	M30x2	36	24.5	12.5	DPR20S
M25S	25		M36x2	46	27	12.5	DPR25S	
M30S	30	M45x2	50	29	13	DPR30S		
M38S	38	M52x2	60	32.5	13.5	DPR38S		

Dual Function Nut - FM

Soft Sealing Ring - DOZ

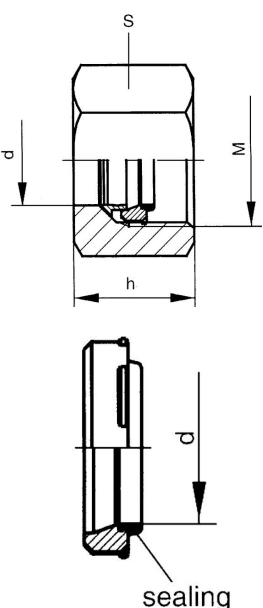

FM Part No.	Series	d Tube o.d.	M	S	DOZ Part No.
-FM06L	L light	6	M12x1.5	14	DOZ06L
-FM08L		8	M14x1.5	17	DOZ08L
-FM10L		10	M16x1.5	19	DOZ10L
-FM12L		12	M18x1.5	22	DOZ12L
-FM15L		15	M22x1.5	27	DOZ15L
-FM18L		18	M26x1.5	32	DOZ18L
-FM22L		22	M30x2	36	DOZ22L
-FM28L		28	M36x2	41	DOZ28L
-FM35L		35	M45x2	50	DOZ35L
-FM42L		42	M52x2	60	DOZ42L
-FM06S	S heavy	6	M12x1.5	17	DOZ06
-FM08S		8	M14x1.5	19	DOZ08
-FM10S		10	M16x1.5	22	DOZ10L
-FM12S		12	M18x1.5	24	DOZ12L
-FM14S		14	M22x1.5	27	DOZ14S
-FM16S		16	M24x1.5	30	DOZ16S
-FM20S		20	M30x2	36	DOZ20S
-FM25S		25	M36x2	46	DOZ25S
-FM30S		30	M45x2	50	DOZ30S
-FM38S		38	M52x2	60	DOZ38S

Fitting Cap - VKA

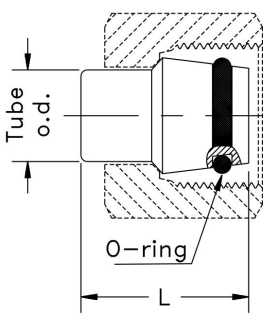

VKA Part no.	Series Working Pressure (bar/psi)	Tube o.d.	L	O-Ring
VKA06	L Light 315 bar 4560 psi	6	18.5	4.5 x 1.5
VKA08		8	18.5	6.5 x 1.5
VKA10		10	20	8 x 1.5
VKA12		12	20.5	10 x 1.5
VKA15		15	20.5	12 x 2
VKA18		18	22.5	15 x 2
VKA22	160 bar 2320 psi	22	25	20 x 2
VKA28		28	25.5	26 x 2
VKA35		35	30	32 x 2.5
VKA42		42	30	38 x 2.5
VKA06	S Heavy 630 bar 9130 psi	6	18.5	4.5 x 1.5
VKA08		8	18.5	6.5 x 1.5
VKA10		10	20	8 x 1.5
VKA12		12	20.5	10 x 1.5
VKA14		14	22.5	11 x 2
VKA16	400 bar 5800 psi	16	23.5	13 x 2
VKA20		20	28.5	16.3 x 2.4
VKA25		25	29	20.3 x 2.4
VKA30		30	30.5	25.3 x 2.4
VKA38	315 bar 4560 psi	38	33	33.3 x 2.4

Tube End Plug - ROV

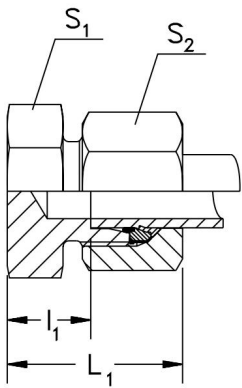

ROV Part no.	Series Working Pressure (bar/psi)	Tube o.d.	l1	L1	S1	S2
ROV06L	L Light 315 bar 4560 psi	6	7	22	12	14
ROV08L		8	8	23	14	17
ROV10L		10	9	24	17	19
ROV12L		12	10	25	19	22
ROV15L		15	11	26	24	27
ROV18L		18	11.5	28	27	32
ROV22L	160 bar	22	13.5	30	32	36
ROV28L	2320 psi	28	14.5	31	41	41
ROV35L		35	14.5	36	46	50
ROV42L		42	16	39	55	60
ROV06S	S Heavy 630 bar 9130 psi	6	11	26	14	17
ROV08S		8	13	28	17	19
ROV10S		10	12.5	29	19	22
ROV12S		12	14.5	31	22	24
ROV14S		14	16	34	24	27
ROV16S			16	15.5	34	27
ROV20S	400 bar	20	17.5	39	32	36
ROV25S	5800 psi	25	20	44	41	46
ROV30S		30	20.5	47	46	50
ROV38S	315 bar 4560 psi	38	23	54	55	60

Non-Return Valve - RHD

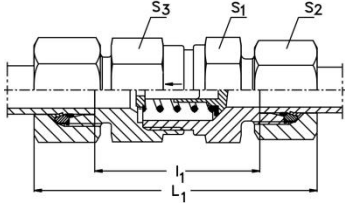

RHD Part no.	Series Working Pressure (bar/psi)	Tube o.d.	S1	S2	S3	L1	l1	DN Size	
RHD06L	L Light 250 bar 3625 psi	6	17	14	17	58	29	4	
RHD08L		8	19	17	19	59	30	6	
RHD10L		10	22	19	24	69.5	40.5	8	
RHD12L		12	27	22	30	72.5	43.5	10	
RHD15L		15	27	27	32	77.5	47.5	12	
RHD18L		160 bar	18	36	32	36	83.5	51.5	16
RHD22L	2320 psi	22	41	36	46	93.5	61.5	20	
RHD28L	100 bar	28	50	41	55	102.5	69.5	25	
RHD35L	1450 psi	35	60	50	60	117.5	74.5	32	
RHD42L		42	65	60	70	119	74	32	
RHD06S	S Heavy 400 bar 5800 psi	6	19	17	19	63.5	34.5	3	
RHD08S		8	19	19	19	63.5	34.5	4	
RHD10S		10	22	22	24	72.5	40.5	6	
RHD12S		12	24	24	27	74.5	42.5	8	
RHD14S		315 bar	14	27	27	32	82.5	47.5	10
RHD16S		4560 psi	16	32	30	36	86.5	50.5	12
RHD20S	250 bar	20	41	36	46	97.5	54.5	16	
RHD25S	3625 psi	25	46	46	50	106.5	58.5	20	
RHD30S		30	60	50	60	122.5	69.5	25	
RHD38S		38	65	60	70	136.5	75.5	32	

Non-Return Valve - RHV-R-ED

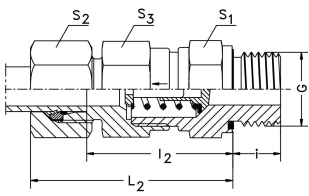
	RHD-R	Series Working Pressure (bar/psi)	Tube o.d.	S1	S2	S3	L2	I2	I	BSP Thread G
	Part no.									
	RHV06LRED	L Light 250 bar 3625 psi	6	17	14	17	42.5	29	8	G 1/8A
	RHV08LRED		8	19	17	19	44.5	30	12	G 1/4A
	RHV10LRED		10	22	19	24	53	40.5	12	G 1/4A
	RHV12LRED		12	27	22	30	57	43.5	12	G 3/8A
	RHV15LRED		15	27	27	32	60.5	47.5	14	G 1/2A
	RHV18LRED	160 bar	18	36	32	36	66	51.5	14	G 1/2A
	RHV22LRED	2320 psi	22	41	36	46	71	61.5	16	G 3/4A
	RHV28LRED	100 bar	28	50	41	55	79.5	69.5	18	G 1 A
	RHV35LRED	1450 psi	35	60	50	60	90.5	74.5	20	G 1 1/4A
	RHV42LRED		42	65	60	70	91	74	22	G 1 1/2A
	RHV06SRED	S Heavy 400 bar 5800 psi	6	19	17	19	46	34.5	12	G 1/4A
	RHV08SRED		8	19	19	19	46	34.5	12	G 1/4A
	RHV10SRED		10	22	22	24	54	40.5	12	G 3/8A
	RHV12SRED		12	24	24	27	57	42.5	12	G 3/8A
	RHV14SRED	315 bar	14	27	27	32	62	47.5	14	G 1/2A
	RHV16SRED	4560 psi	16	32	30	36	66	50.5	14	G 1/2A
	RHV20SRED	250 bar	20	41	36	46	73.5	54.5	16	G 3/4A
	RHV25SRED	3625 psi	25	46	46	50	78.5	58.5	18	G 1 A
	RHV30SRED		30	60	50	60	90.5	69.5	20	G 1 1/4A
	RHV38SRED		38	65	60	70	100	75.5	22	G 1 1/2A

Non-Return Valve - RHV-M-ED

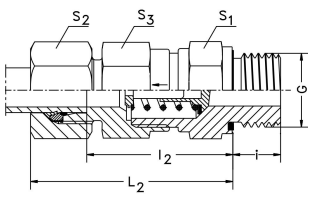
	RHV-M	Series Working Pressure (bar/psi)	Tube o.d.	S1	S2	S3	L2	I2	I	BSP Thread G
	Part no.									
	RHV06LMED	L Light 250 bar 3625 psi	6	17	14	17	42.5	28	8	M 10x1
	RHV08LMED		8	19	17	19	44.5	29	12	M 12X1.5
	RHV10LMED		10	22	19	24	53	38.5	12	M 14X1.5
	RHV12LMED		12	27	22	30	57	42.5	12	M 16X1.5
	RHV15LMED		15	27	27	32	60.5	45.5	12	M 18X1.5
	RHV18LMED	160 bar	18	36	32	36	66	50	14	M 22X1.5
	RHV22LMED	2320 psi	22	41	36	46	71	55	16	M 26X1.5
	RHV28LMED	100 bar	28	50	41	55	79.5	63	18	M 33X2
	RHV35LMED	1450 psi	35	60	50	60	90.5	69	20	M 42X2
	RHV42LMED		42	65	60	70	91	68.5	22	M 48X2
	RHV06SMED	S Heavy 400 bar 5800 psi	6	19	17	19	46	31.5	12	M 12X1.5
	RHV08SMED		8	19	19	19	46	31.5	12	M 14X1.5
	RHV10SMED		10	22	22	24	54	38	12	M 16X1.5
	RHV12SMED		12	24	24	27	57	41	12	M 18X1.5
	RHV14SMED	315 bar	14	27	27	32	62	44.5	14	M 20X1.5
	RHV16SMED	4560 psi	16	32	30	36	66	48	14	M 22X1.5
	RHV20SMED	250 bar	20	41	36	46	73.5	52	16	M 27X2
	RHV25SMED	3625 psi	25	46	46	50	78.5	54.5	18	M 33X2
	RHV30SMED		30	60	50	60	90.5	64	20	M 42X2
	RHV38SMED		38	65	60	70	100	69.5	22	M 48X2

Non-Return Valve - RHZ-R-ED

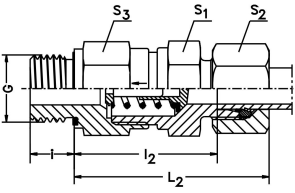
	RHZ-R	Series	Tube	S1	S2	S3	L2	I2	I	BSP
	Part no.	Working Pressure (bar/psi)	o.d.							Thread G
	RHZ06LRED	L Light 250 bar 3625 psi	6	17	14	17	41	26.5	8	G 1/8A
	RHZ08LRED		8	19	17	19	43	28.5	12	G 1/4A
	RHZ10LRED		10	22	19	24	53	38.5	12	G 1/4A
	RHZ12LRED		12	27	22	30	55	40.5	12	G 3/8A
	RHZ15LRED		15	27	27	32	57.5	42.5	14	G 1/2A
	RHZ18LRED	160 bar	18	36	32	36	64	48	14	G 1/2A
	RHZ22LRED	2320 psi	22	41	36	46	72	56	16	G 3/4A
	RHZ28LRED	100 bar	28	50	41	55	80.5	64	18	G 1 A
	RHZ35LRED	1450 psi	35	60	50	60	91.5	70	20	G 1 1/4A
	RHZ42LRED		42	65	60	70	93	70.5	22	G 1 1/2A
	RHZ06SRED	S Heavy 400 bar 5800 psi	6	19	17	19	46	31.5	12	G 1/4A
	RHZ08SRED		8	19	19	19	46	31.5	12	G 1/4A
	RHZ10SRED		10	22	22	24	54	38	12	G 3/8A
	RHZ12SRED		12	24	24	27	57	41	12	G 3/8A
	RHZ14SRED	315 bar	14	27	27	32	61	43.5	14	G 1/2A
	RHZ16SRED	4560 psi	16	32	30	36	64	46	14	G 1/2A
	RHZ20SRED	250 bar	20	41	36	46	71.5	50	16	G 3/4A
	RHZ25SRED	3625 psi	25	46	46	50	78.5	54.5	18	G 1 A
	RHZ30SRED		30	60	50	60	90.5	64	20	G 1 1/4A
	RHZ38SRED		38	65	60	70	102	71.5	22	G 1 1/2A

Non-Return Valve - RHZ-M-ED

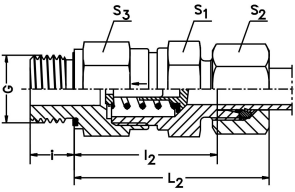
	RHZ-M	Series	Tube	S1	S2	S3	L2	I2	I	BSP
	Part no.	Working Pressure (bar/psi)	o.d.							Thread G
	RHZ06LMED	L Light 250 bar 3625 psi	6	17	14	17	41	26.5	8	M 10x1
	RHZ08LMED		8	19	17	19	43	28.5	12	M 12X1.5
	RHZ10LMED		10	22	19	24	53	38.5	12	M 14X1.5
	RHZ12LMED		12	27	22	30	55	40.5	12	M 16X1.5
	RHZ15LMED		15	27	27	32	57.5	42.5	12	M 18X1.5
	RHZ18LMED	160 bar	18	36	32	36	64	48	14	M 22X1.5
	RHZ22LMED	2320 psi	22	41	36	46	72	56	16	M 26X1.5
	RHZ28LMED	100 bar	28	50	41	55	80.5	64	18	M 33X2
	RHZ35LMED	1450 psi	35	60	50	60	91.5	70	20	M 42X2
	RHZ42LMED		42	65	60	70	93	70.5	22	M 48X2
	RHZ06SMED	S Heavy 400 bar 5800 psi	6	19	17	19	46	31.5	12	M 12X1.5
	RHZ08SMED		8	19	19	19	46	31.5	12	M 14X1.5
	RHZ10SMED		10	22	22	24	54	38	12	M 16X1.5
	RHZ12SMED		12	24	24	27	57	41	12	M 18X1.5
	RHZ14SMED	315 bar	14	27	27	32	61	43.5	14	M 20X1.5
	RHZ16SMED	4560 psi	16	32	30	36	64	46	14	M 22X1.5
	RHZ20SMED	250 bar	20	41	36	46	71.5	50	16	M 27X2
	RHZ25SMED	3625 psi	25	46	46	50	78.5	54.5	18	M 33X2
	RHZ30SMED		30	60	50	60	90.5	64	20	M 42X2
	RHZ38SMED		38	65	60	70	102	71.5	22	M 48X2

Non-Return Valve - RHDI

	RHDI Part no.	Series Working Pressure (bar/psi)	G	S1	S3	L	t1	t2	D	d
	RHDI-1/8	400 bar	G1/8	19	19	42.5	8	12	19	3.5
	RHDI-1/4	5800 psi	G1/4	19	19	51	12	16	19	3.5
	RHDI-3/8		G3/8	24	27	60	12	17	24	7.5
	RHDI-1/2	315 bar 4560 psi	G1/2	32	36	72	15	20	32	11.5
	RHDI-3/4	250 bar	G3/4	42	46	84	16.5	22	41	15
	RHDI-1	3625 psi	G 1	46	50	95	19	25.5	46	19
	RHDI-1 1/4		G1 1/4	60	60	110	21.5	28	60	24
	RHDI-1 1/2		G1 1/2	65	70	114	22	28.5	65	29

Non-Return Valve - RVP

<p>Cartridge Valve</p>	RVP Part no.	Series Working Pressure (bar/psi)	L	d	l1	l2	D	D1	O-ring
	RVP13	400 bar	23	3.5	9.5	6	13	13	8.3*2.4
	RVP16	5800 psi	26.5	5.5	9.5	6.5	16	16	11.3*2.4
	RVP20		30	7.5	9.5	6.5	20	20	15.3*2.4
	RVP24	315 bar	35	9.5	12	7.5	24	24	18.2*3
	RVP27	4560 psi	38	11.5	12	7.5	27	27	21.2*3
	RVP35	250 bar	44.5	15.3	12	9.5	35	35	29.2*3
	RVP40	3625 psi	50.5	19.3	12	11	40	40	34.2*3
	RVP47		60	24.3	13	13	47	47	41.2*3
	RVP55		70	29.4	16	13	55	55	44.2*5.7

Nantong ROKE Fluid Equipment Co.,LTD

ROKE Factory

Pingchao Town, Tongzhou Area
Nantong City, Jiangsu Province,China
Tel :86-513-86751377
Fax:86-513-86752577

ROKE Office

Room 1108 .Building B. Jianghaicaifudasha
No.817.Jianghai Avenue.Gangzha Area
Nantong City, Jiangsu Province,China
Tel: 86-513-85400443
Fax:86-513-85400444
Web:www.chinaroke.com
E-mail:sales01@ntroke.com

ROKE
Valves and Fittings

www.chinaroke.com